

Hikrobot Co., Ltd.

ID3000X & ID3000R Series Industrial Code Reader

User Manual

HIKROBOT

Legal Information

© Hangzhou Hikrobot Co., Ltd. All rights reserved.

About this Document

This Document includes instructions for using and managing the Product. Pictures, charts, images and all other information hereinafter are for description and explanation only. The information contained in the Document is subject to change, without notice, due to firmware updates or other reasons. Please find the latest version in the company website (<https://en.hikrobotics.com/>). Unless otherwise agreed, Hangzhou Hikrobot Co., Ltd. or its affiliates (hereinafter referred to as “Hikrobot”) makes no warranties, express or implied. Please use the Document with the guidance and assistance of professionals trained in supporting the Product.

Acknowledgment of Intellectual Property Rights

- Hikrobot owns the copyrights and/or patents related to the technology embodied in the Products described in this Document, which may include licenses obtained from third parties. Any part of the Document, including text, pictures, graphics, etc., belongs to Hikrobot. No part of this Document may be excerpted, copied, translated, or modified in whole or in part by any means without written permission.
- **HIKROBOT** and other Hikrobot's trademarks and logos are the properties of Hikrobot in various jurisdictions. Other trademarks and logos mentioned are the properties of their respective owners.

LEGAL DISCLAIMER

TO THE MAXIMUM EXTENT PERMITTED BY APPLICABLE LAW, THIS MANUAL AND THE PRODUCT DESCRIBED, WITH ITS HARDWARE, SOFTWARE AND FIRMWARE, ARE PROVIDED "AS IS" AND "WITH ALL FAULTS AND ERRORS". HIKROBOT MAKES NO WARRANTIES, EXPRESS OR IMPLIED, INCLUDING WITHOUT LIMITATION, MERCHANTABILITY, SATISFACTORY QUALITY, OR FITNESS FOR A PARTICULAR PURPOSE. THE USE OF THE PRODUCT BY YOU IS AT YOUR OWN RISK. IN NO EVENT WILL HIKROBOT BE LIABLE TO YOU FOR ANY SPECIAL, CONSEQUENTIAL, INCIDENTAL, OR INDIRECT DAMAGES, INCLUDING, AMONG OTHERS, DAMAGES FOR LOSS OF BUSINESS PROFITS, BUSINESS INTERRUPTION, OR LOSS OF DATA, CORRUPTION OF SYSTEMS, OR LOSS OF DOCUMENTATION, WHETHER BASED ON BREACH OF CONTRACT, TORT (INCLUDING NEGLIGENCE), PRODUCT LIABILITY, OR OTHERWISE, IN CONNECTION WITH THE USE OF THE PRODUCT, EVEN IF HIKROBOT HAS BEEN ADVISED OF THE POSSIBILITY OF SUCH DAMAGES OR LOSS.

YOU ACKNOWLEDGE THAT THE NATURE OF INTERNET PROVIDES FOR INHERENT SECURITY RISKS, AND HIKROBOT SHALL NOT TAKE ANY RESPONSIBILITIES FOR ABNORMAL OPERATION, PRIVACY LEAKAGE OR OTHER DAMAGES RESULTING FROM CYBER-ATTACK, HACKER ATTACK, VIRUS INFECTION, OR OTHER INTERNET SECURITY RISKS; HOWEVER, HIKROBOT WILL PROVIDE TIMELY TECHNICAL SUPPORT IF REQUIRED.

YOU AGREE TO USE THIS PRODUCT IN COMPLIANCE WITH ALL APPLICABLE LAWS, AND

YOU ARE SOLELY RESPONSIBLE FOR ENSURING THAT YOUR USE CONFORMS TO THE APPLICABLE LAW. ESPECIALLY, YOU ARE RESPONSIBLE, FOR USING THIS PRODUCT IN A MANNER THAT DOES NOT INFRINGE ON THE RIGHTS OF THIRD PARTIES, INCLUDING WITHOUT LIMITATION, RIGHTS OF PUBLICITY, INTELLECTUAL PROPERTY RIGHTS, OR DATA PROTECTION AND OTHER PRIVACY RIGHTS. YOU SHALL NOT USE THIS PRODUCT FOR ANY PROHIBITED END-USES, INCLUDING THE DEVELOPMENT OR PRODUCTION OF WEAPONS OF MASS DESTRUCTION, THE DEVELOPMENT OR PRODUCTION OF CHEMICAL OR BIOLOGICAL WEAPONS, ANY ACTIVITIES IN THE CONTEXT RELATED TO ANY NUCLEAR EXPLOSIVE OR UNSAFE NUCLEAR FUEL-CYCLE, OR IN SUPPORT OF HUMAN RIGHTS ABUSES.

THE PERFORMANCE DATA IN THIS PUBLICATION IS BASED ON HIKROBOT'S INTERNAL RESEARCH/EVALUATION. ACTUAL DATA MAY VARY DEPENDING ON SPECIFIC CONFIGURATIONS AND OPERATING CONDITIONS AND HIKROBOT SHALL NOT BEAR THE CONSEQUENCES ARISING THEREFROM.

IN THE EVENT OF ANY CONFLICTS BETWEEN THIS MANUAL AND THE APPLICABLE LAW, THE LATTER PREVAILS.

Regulatory Information

Note

These clauses apply only to the products bearing the corresponding mark or information.

EU Conformity Statement



This product and - if applicable - the supplied accessories too are marked with "CE" and comply therefore with the applicable harmonized European standards listed under the Directive 2014/30/EU(EMCD), Directive 2001/95/EC(GPSD) and Directive 2011/65/EU(RoHS).



2012/19/EU (WEEE directive): Products marked with this symbol cannot be disposed of as unsorted municipal waste in the European Union. For proper recycling, return this product to your local supplier upon the purchase of equivalent new equipment, or dispose of it at designated collection points. For more information see: <http://www.recyclethis.info>



Regulation (EU) 2023/1542(Battery Regulation): This product contains a battery and it is in conformity with the Regulation (EU) 2023/1542. The battery cannot be disposed of as unsorted municipal waste in the European Union. See the product documentation for specific battery information. The battery is marked with this symbol, which may include lettering to indicate cadmium (Cd), or lead (Pb). For proper recycling, return the battery to your supplier or to a designated collection point. For more information see: www.recyclethis.info.

This is a class A product. In a domestic environment this product may cause radio interference in which case the user may be required to take adequate measures.



KC Mark Certification

Class A: The device is advised to note that as a seller or a business user (Class A) Devices and intended for use outside the Home area.

A급 기기: 이 기기는 업무용(A급) 전자파적합기기로서 판매자 또는 사용자는 이 점을 주의하시기바라며, 가정 외의 지역에서 사용하는 것을 목적으로 합니다.

Symbol Conventions

The symbols that may be found in this document are defined as follows.

Symbol	Description
 Danger	Indicates a hazard with a high level of risk, which if not avoided, will result in death or serious injury.
 Caution	Indicates a potentially hazardous situation which, if not avoided, could result in equipment damage, data loss, performance degradation, or unexpected results.
 Note	Provides additional information to emphasize or supplement important points of the main text.

Available Model

This manual is applicable to the ID3000X & ID3000R Series Industrial Code Reader.

Contact Information

Hangzhou Hikrobot Co., Ltd.

E-mail: global.support@hikrobotics.com

Website: <https://en.hikrobotics.com/>

Contents

Chapter 1 Safety Instruction	1
1.1 Safety Claim	1
1.2 Safety Instruction	1
1.3 Electromagnetic Interference Prevention.....	2
Chapter 2 Overview	4
2.1 Introduction	4
2.2 Key Feature.....	4
2.3 Overall Workflow of Using Device.....	5
Chapter 3 Appearance	6
Chapter 4 12-Pin Connector and Indicator	8
4.1 12-Pin Connector.....	8
4.2 Indicator.....	9
Chapter 5 Device Installation and Wiring	10
5.1 Installation Preparation.....	10
5.2 Install Device	11
5.3 Wire Device.....	12
Chapter 6 I/O Electrical Feature and I/O Wiring	14
6.1 I/O Electrical Feature	14
6.1.1 Input Signal	14
6.1.2 Output Signal.....	15
6.2 I/O Wiring.....	16
6.2.1 Input Signal Wiring	16
6.2.2 Output Signal Wiring	17
6.3 RS-232 Serial Port.....	18
6.3.1 RS-232 Serial Port Introduction.....	18
6.3.2 RS-232 Serial Port Wiring.....	19
Chapter 7 Device Connection	20
7.1 Install Client Software	20
7.2 Set PC Network	21

7.3 Set Device Network and Connect to Client Software	22
Chapter 8 Basic Operation	23
8.1 Client Software Layout	23
8.2 Basic Operation	24
Chapter 9 Device Settings	27
9.1 Feature Tree Introduction	27
9.2 Image Quality Settings	28
9.2.1 Set Image Parameters	29
9.2.2 Set Exposure	30
9.2.3 Set Gain	31
9.2.4 Set Polling	31
9.2.5 Set Light Source	35
9.2.6 Set Smart Tune	36
9.2.7 Set Auto Focus	37
9.2.8 Set Fast Focus	40
9.2.9 Set Self-Adaptive Adjustment	41
9.2.10 Set Mirror X	42
9.2.11 Set Test Pattern	43
9.3 Code Algorithm Settings	43
9.3.1 Add Code	43
9.3.2 Set Code Reading ROI	44
9.3.3 Set Algorithm Parameter	46
9.3.4 Set Code Quality Evaluation	48
9.3.5 Set Code Score	50
9.4 Signal Input Settings	51
9.4.1 Set Trigger Mode	51
9.4.2 Enable Internal Trigger Mode	51
9.4.3 Enable External Trigger Mode	51
9.4.4 Stop Trigger	56
9.5 Signal Output Settings	60
9.5.1 Select Output Signal	60
9.5.2 Set Event Source	60

9.5.3 Enable Line Inverter	69
9.6 Communication Settings	69
9.6.1 Set SmartSDK.....	69
9.6.2 Set TCP Client	70
9.6.3 Set Serial.....	70
9.6.4 Set FTP.....	71
9.6.5 Set TCP Server	71
9.6.6 Set Profinet.....	71
9.6.7 Set MELSEC.....	72
9.6.8 Set Ethernet/IP	73
9.6.9 Set ModBus	73
9.6.10 UDP	74
9.6.11 Fins.....	74
9.7 Data Processing Settings.....	75
9.7.1 Set Filter Rule	75
9.7.2 Data Processing Settings.....	79
9.8 Contrast Control Settings	81
9.9 Statistics Information	83
9.10 Diagnose Event Report	84
9.11 User Set Customization	85
Chapter 10 Device Maintenance	87
10.1 Update Firmware.....	87
10.2 Set Time.....	87
10.3 Enable Device Auto Work.....	88
10.4 Restart Device	89
Chapter 11 FAQ (Frequently Asked Question)	90
11.1 Why there is no device listed after I run the IDMVS client software?	90
11.2 Why the image is very dark?.....	90
11.3 Why the image's frame rate is very low in the live view?	90
11.4 Why there is no image in the live view?	91

Chapter 1 Safety Instruction

The safety instructions are intended to ensure that the user can use the device correctly to avoid danger or property loss. Read and follow these safety instructions before installing, operating and maintaining the device.

1.1 Safety Claim

- To ensure personal and device safety, when installing, operating, and maintaining the device, follow the signs on the device and all safety instructions described in the manual.
- The note, caution and danger items in the manual do not represent all the safety instructions that should be observed, but only serve as a supplement to all the safety instructions.
- The device should be used in an environment that meets the design specifications, otherwise it may cause malfunctions, and malfunctions or component damage caused by non-compliance with relevant regulations are not within the scope of the device's quality assurance.
- Our company will not bear any legal responsibility for personal safety accidents and property losses caused by abnormal operation of the device.

1.2 Safety Instruction



Caution

- Do not install the device if it is found that the device and accessories are damaged, rusted, water ingress, model mismatch, missing parts, etc., when unpacking.
- Avoid storage and transportation in places such as water splashing and rain, direct sunlight, strong electric fields, strong magnetic fields, and strong vibrations.
- Avoid dropping, smashing or vigorously vibrating the device and its components.
- It is forbidden to install the indoor device in an environment where it may be exposed to water or other liquids. If the device is damp, it may cause fire and electric shock hazard.
- If the device emits smoke, odor or noise, please turn off the power and unplug the power cord immediately, and contact the dealer or service center in time.
- In the use of the device, you must be in strict compliance with the electrical safety regulations of the nation and region.
- Use the power adapter provided by the official manufacturer. The power adapter must meet the Limited Power Source (LPS) requirements. For specific requirements, please refer to the device's technical specifications.
- Do not cover the device's plug or outlet for disconnecting power supply.
- It is strictly forbidden to wire, maintain, and disassemble the device is powered on. Otherwise, there is a danger of electric shock.
- Do not directly touch cooling parts of the device to avoid scald.

- Looking directly at the device may cause harm to the eyes. Protective measures like wearing protective glasses should be taken in the process of installation, maintenance and debugging.
- Avoid aiming the lens at strong light such as lighting, sunlight, or laser beams, etc., otherwise the image sensor will be damaged.
- It is forbidden to touch the image sensor directly. If necessary, please moisten a soft clean cloth with alcohol and gently wipe off the dust. When the device is not in use, please add a dust cover to protect the image sensor.
- If the device does not work properly, please contact your dealer or the nearest service center. Never attempt to disassemble the device yourself. We shall not assume any responsibility for problems caused by unauthorized repair or maintenance.
- Please dispose of the device in strict accordance with the relevant national or regional regulations and standards to avoid environmental pollution and property damage.

Note

- Check whether the device's package is in good condition, whether there is damage, intrusion, moisture, deformation, etc. before unpacking.
- Check the surface of the device and accessories for damage, rust, bumps, etc. when unpacking.
- Check whether the quantity and information of the device and accessories are complete after unpacking.
- Store and transport the device according to the storage and transport conditions of the device, and the storage temperature and humidity should meet the requirements.
- It is strictly prohibited to transport the device in combination with items that may affect or damage the device.
- The device should not be placed with exposed flame sources, such as lighted candles.
- Please read the manual and safety instructions carefully before installing the device.
- Quality requirements for installation and maintenance personnel:
 - Qualification certificate or working experience in weak current system installation and maintenance, and relevant working experience and qualifications. Besides, the personnel must possess the following knowledge and operation skills.
 - The basic knowledge and operation skills of low voltage wiring and low voltage electronic circuit connection.
 - The ability to comprehend the contents of this manual.

1.3 Electromagnetic Interference Prevention

- Make sure that the shielding layer of cables is intact and 360° connected to the metal connector when using shielded cables.
- Do not route the device together with other equipment (especially servo motors, high-power devices, etc.), and control the distance between cables to more than 10 cm. Make sure to shield the cables if unavoidable.
- The control cable of the device and the power cable of the industrial light source must be wired separately to avoid bundled wiring.
- The power cable, data cable, signal cable, etc. of the device must be wired separately.

Make sure to ground them if the wiring groove is used to separate the wiring and the wiring groove is metal.

- During the wiring process, evaluate the wiring space reasonably, and do not pull the cables hard, so as not to damage the electrical performance of the cables.
- If the device is powered on and off frequently, it is necessary to strengthen the voltage isolation, and consider adding a DC/DC isolation power supply module between the device and the adapter.
- Use the power adapter to supply power to the device separately. If centralized power supply is necessary, make sure to use a DC filter to filter the power supply of the device separately before use.
- The unused cables of the device must be insulated.
- When installing the device, if you cannot ensure that the device itself and all equipment connected to the device are well grounded, you should isolate the device with an insulating bracket.
- To avoid the accumulation of static electricity, ensure that other equipment (such as machines, internal components, etc.) and metal brackets on site are properly grounded.
- Make sure that the connector metal barrier of the device is well connected to the PC and other chassis, and if necessary, copper foil should be used to enhance the grounding effect.
- During the installation and use of the device, high voltage leakage must be avoided.
- Use a figure-eight bundle method if the device cable is too long.
- When connecting the device and metal accessories, they must be connected firmly to maintain good conductivity.
- Use a shielded network cable to connect to the device. If you use a self-made network cable, make sure that the shielding shell at the aviation head is well connected to the aluminum foil or metal braid of the shielding cable.

Chapter 2 Overview

2.1 Introduction

With functions of image acquisition, code recognition and output, the ID3000X & ID3000R series industrial code reader industrial code reader can read different types of 1D codes and 2D codes. It adopts deep learning algorithm to process images with good robustness, and can recognize various complex codes.

The device is applicable to consumer electronics, food and medicine, automobile spare parts, electronics semiconductor, and other industries.

2.2 Key Feature

- Adopts built-in deep learning algorithm to read codes with good robustness.
- Adopts CMOS sensor to acquire high-quality images.
- Supports one-key auto adjustment and easy to operate.
- Adopts IO interfaces for input and output signals.
- Supports 180° rotation structure, status indicator and focus adjustment methods.
- Modularized light source design and easy to replace.

Note

- The specific functions may differ by device models.
 - Refer to the device's specifications for specific parameters.
-

2.3 Overall Workflow of Using Device

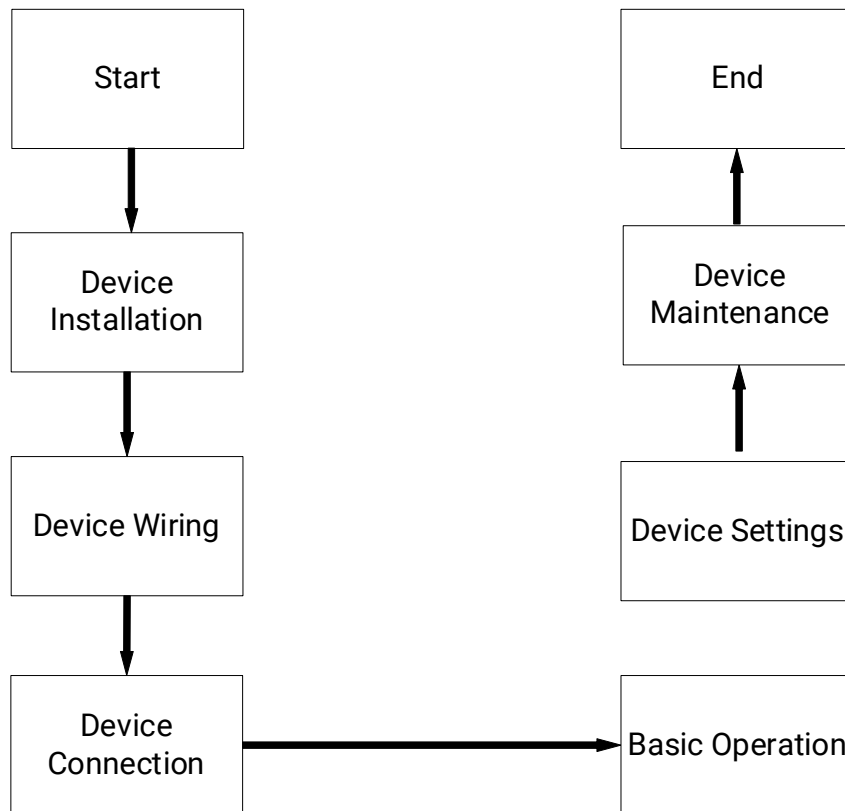

Figure 2-1 Workflow

The overall workflow of using the device is show below. You can follow the workflow and the corresponding sections in this manual to use and configure the device.

- Refer to section **Device Installation and Wiring** for how to install and wire the device.
- Refer to section **Device Connection** for how to install the client software, set PC network, and connect the device to the client software.
- Refer to section **Basic Operation** for how to set the device's operation mode, and run the client software.
- Refer to section **Device Settings** for how to set the device's parameters like image quality, algorithm, input and output, communication, etc.
- Refer to section **Device Maintenance** for how to update the device's firmware, restart device, etc.

Chapter 3 Appearance

Note



Appearance here is for reference only. Refer to the device's specification for detailed dimension information.



Figure 3-1 Appearance

Table 3-1 Component Description

No.	Name	Description
1	Lens Cap	The device adopts transparent + polarized + diffused lens cap, which helps the improvement of code recognition rate. Note It can be replaced with other lens cap according to actual demands.
2	Image Sensor	It is used to acquire images.
3	Light Source	It is the red LED light source by default used to provide light when the device acquires images. Note The white/blue/IR light source is optional.

No.	Name	Description
4	Aiming System	It is orange LED light used to show the field of view and aim targets.
5	Code Reading Result Indicator	It is used to indicate the device's code reading result. <ul style="list-style-type: none"> ● It is green light if the code reading succeeds. ● It is red light if the code reading fails.
6	TOF	It is used to detect the position of targets, and realize focus and image parameter adjustment.  Note TOF function is applicable to the device with liquid lens only.
7	Trigger Button	It is used to trigger the device via pressing the button. <ul style="list-style-type: none"> ● If the device is in continuous acquisition mode, press the button and the device enters trigger mode. ● If the device is in trigger mode, press the button and the device triggers once.
8	Smart Tune Button	It is used to realize smart tune of the device's parameters by pressing the tune button. <ul style="list-style-type: none"> ● Hold the button for 2 sec and the device starts smart tune. ● Hold the button for 2 sec again during smart tune process, and the adjustment will be cancelled.  Note The smart tune function is not available when the client software is connecting the device.
9	Top Indicator	It is a 360 ° visible indicator for observing the device's status.
10	Screw Hole (Back Side)	It is used to fix the device, and you should use M3 screws.
11	Right Angle Rotation Structure	It is used to rotate the device's cables.
12	12-Pin Connector	It provides power and I/O, including opto-isolated input, opto-isolated output, and RS-232.
13	Network Interface	It is fast Ethernet for transmitting data.
14	Screw Hole (Bottom Side)	It is used to connect protective cover, and you should use M3 screws.

Chapter 4 12-Pin Connector and Indicator

4.1 12-Pin Connector

Read the following section to get pin definitions of 12-pin connector.

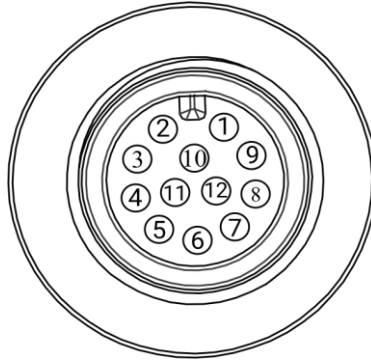

Figure 4-1 12-Pin Connector

Table 4-1 Pin Definitions

No.	Signal	I/O Signal Source	Description	Cable Color
1	DC-PWR	--	Direct current power supply positive	White
2	GND	--	Power supply ground	Brown
3	OPTO_OUT3	Output signal line of pin 3	I/O isolated output 3	Green
4	OPTO_OUT4	Output signal line of pin 4	I/O isolated output 4	Yellow
5	OPTO_OUT5	Output signal line of pin 5	I/O isolated output 5	Gray
6	OUT_COM	Output signal ground of pin 3/4/5	Output common port	Pink
7	OPTO_IN0	Input signal line of pin 0	I/O isolated input 0	Blue
8	OPTO_IN1	Input signal line of pin 1	I/O isolated input 1	Red
9	OPTO_IN2	Input signal line of pin 2	I/O isolated input 2	Black
10	IN_COM	Input signal ground of pin 0/1/2	Input common port	Purple
11	RS-232_R	--	RS232 input	Gray/Pink
12	RS-232_T	--	RS232 output	Red/Blue

 **Note**

You should refer to the table above and the label attached to the supplied power and I/O cable to wire the device.

4.2 Indicator

You can observe the device's top indicator and code reading result indicator to check whether the device operates normally or not.

Table 4-2 Indicator Description

Device Status		Top Indicator	Code Reading Result Indicator
Normal Status	Not Streaming	Solid Blue	Unlit
	Streaming	Unlit	
Exception Status	Power Off	Unlit	
	Network Exception	Solid Yellow	
Code Reading Status	Successful Code Reading	Flashing Green	Flashing Green
	Failed Code Reading	Flashing Red	Flashing Red
Parameter Adjustment Status	Successful Parameter Adjustment	Flashing Green	Unlit
	Failed Parameter Adjustment	Flashing Red	
	Parameter Adjustment Ended (Not Streaming)	Solid Blue	
	Parameter Adjustment Ended (Streaming)	Unlit	

Chapter 5 Device Installation and Wiring

5.1 Installation Preparation

You need to prepare following accessories before installation. The included accessories are in the device's package, and you can purchase optional accessories according to actual demands.

Table 5-1 Included Accessories



No.	Name	Quantity	Description
1	Power and I/O Cable	1	It refers to the 3-meter 12-pin M12 to open cable.
2	M12 Network Cable	1	It refers to the 3-meter M12 to RJ45 network cable.
3	Installation Bracket	1	It is used to fix the device.
4	Lens Cap	1	The device has a transparent + polarized + diffused lens cap by default.  Note It can be replaced with other lens cap according to actual demands.
5	Light Board	1	The device has a light board integrating 4 LED red lamps, 2 code reading result indicators, TOF, etc.  Note It can be replaced with white/blue/IR light board.

Table 5-2 Optional Accessories

No.	Name	Quantity	Description
1	Power Adapter	1	You should select suitable power adapter or switch power supply according to the device power supply and consumption.
2	ESD Protective Cover	1	It is used to achieve ESD protection.
3	Diffuser Cover	1	It is used to suppress background interference.
4	Amplifier Accessory	1	It is used to increase the magnification of the device.
5	YAG Protective Cover	1	It is used to avoid YAG laser.

No.	Name	Quantity	Description
6	Power and I/O Cable	1	You can purchase flexible or different-length 12-pin M12 to open cable according to actual demands.
7	M12 Network Cable	1	You can purchase flexible or different-length M12 to RJ45 network cable according to actual demands.

5.2 Install Device

Before You Start

- Make sure the device in the package is in good condition and all the assembly parts are included.
- Make sure that all the related devices are powered off during the installation.

Steps

1. Select a suitable installation location according to the device's field of view.

Note

Refer to the device's specifications for detection range.

2. Adjust the device's right angle rotation structure according to the installation location.

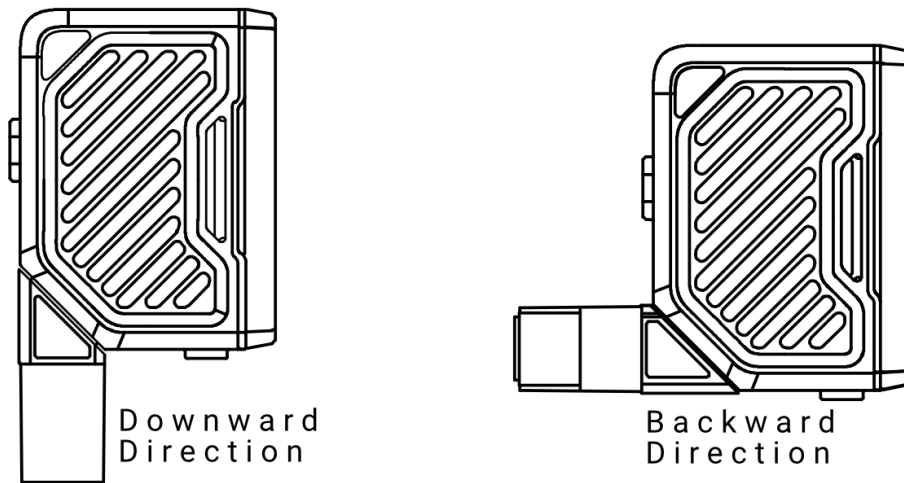

Figure 5-1 Adjust Right Angle Rotation Structure

Note

Refer to the device's specifications for the dimension of the right angle rotation structure.

3. Use M3 screws to fix the installation bracket to the device, as shown below.

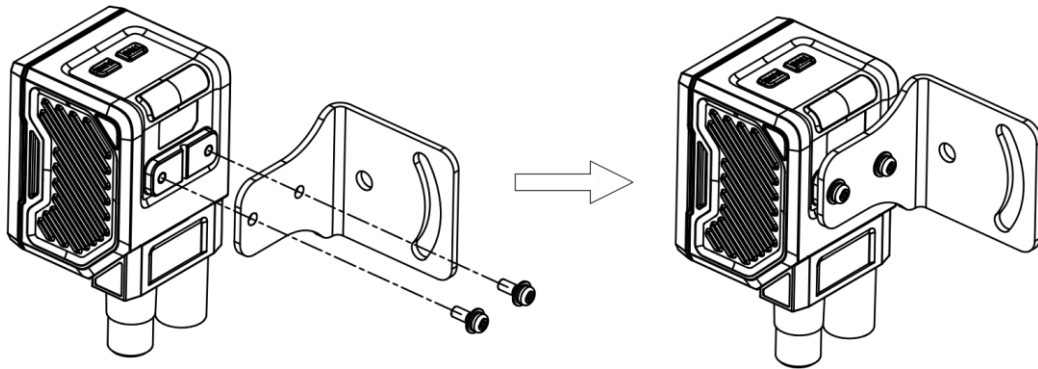

Figure 5-2 Fix Installation Bracket

4. Install the device to the installation location.

5.3 Wire Device

After installing the device, you should use the power and I/O cable, M12 network cable, and power adapter to wire and power the device.

Steps

1. Use the supplied power and I/O cable to connect the device's 12-pin connector.

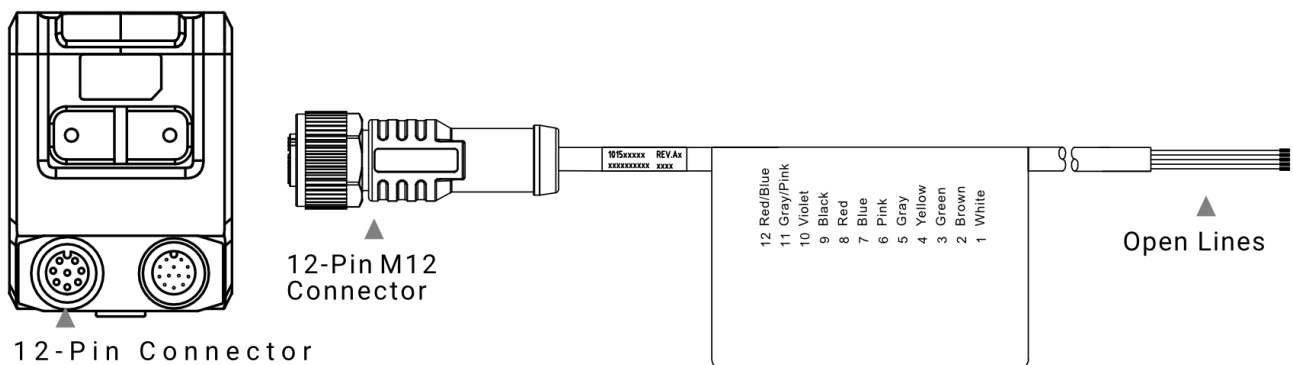

Figure 5-3 Connect Device's 12-Pin Connector

Note

The 12-pin connector has screw thread, and it is recommended to tighten the connector before using the device to reduce looseness due to the vibration on-site.

2. Use the supplied M12 network cable to connect the device's network interface.

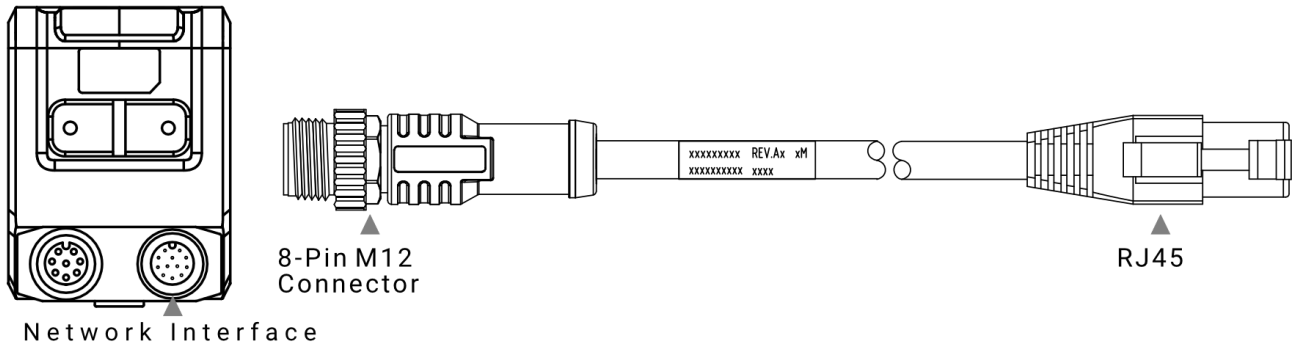

Figure 5-4 Connect Device's Network Interface

3. Insert the RJ45 port of the supplied M12 network cable to the PC.
4. Select suitable power adapter to connect the open lines of the supplied power and I/O cable for power supply.

Note

- The device's top indicator is in blue color after powering on the device.
 - Refer to the pin definitions of the 12-pin connector for specific color of open lines.
-

Chapter 6 I/O Electrical Feature and I/O Wiring

The device's 12-pin connector has three opto-isolated inputs (LineIn 0/1/2), three opto-isolated outputs (LineOut 3/4/5), and one RS-232 serial port. This section introduces the I/O electrical feature and I/O wiring.

6.1 I/O Electrical Feature

This section introduces the electrical feature of opto-isolated input and opto-isolated output.

6.1.1 Input Signal

The device's LineIn 0/1/2 are opto-isolated inputs, and their internal circuit is as follows.

Note

- The input voltage ranges from 5 VDC to 30 VDC.
- The breakdown voltage is 36 VDC. Keep voltage stable.

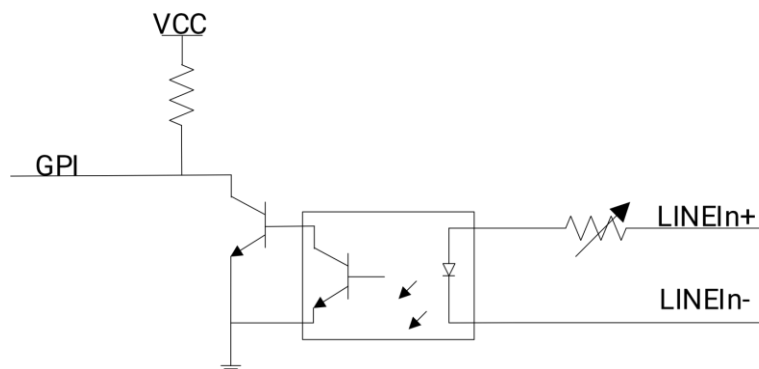

Figure 6-1 Internal Circuit of Input Signal

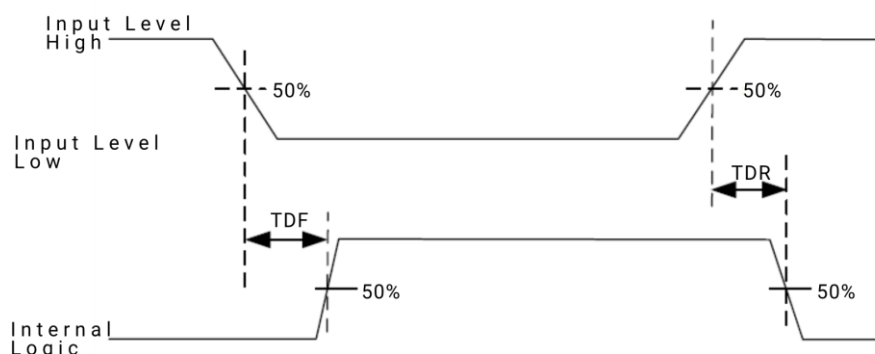

Figure 6-2 Input Logic Level

Table 6-1 Input Electrical Feature

Parameter Name	Symbol	Value
Input Logic Level Low	VL	1.5 VDC
Input Logic Level High	VH	2 VDC
Input Falling Delay	TDF	81.6 μ s
Input Rising Delay	TDR	7 μ s

6.1.2 Output Signal

The device's LineOut 0/1/2 are opto-isolated outputs, and their internal circuit is as follows.

Note

- The output voltage ranges from 5 VDC to 30 VDC.
- The maximum output current is 45 mA.
- Do not directly connect with inductive load (e.g. DC motor, etc.) when outputting.
- If the external voltage and resistance change, the corresponding current of output signal and output logic level low may differ.

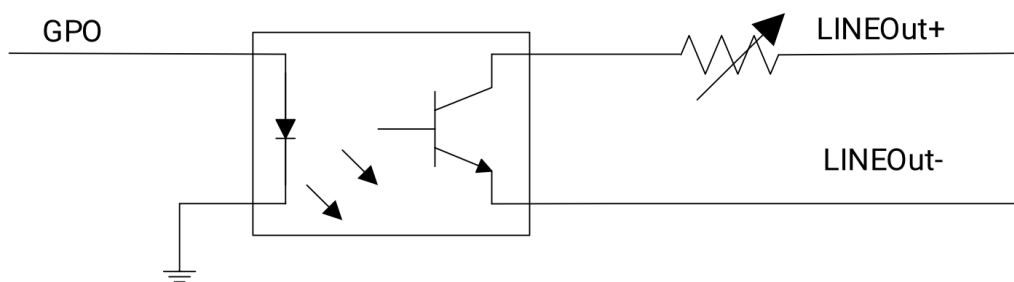

Figure 6-3 Internal Circuit of Output Signal

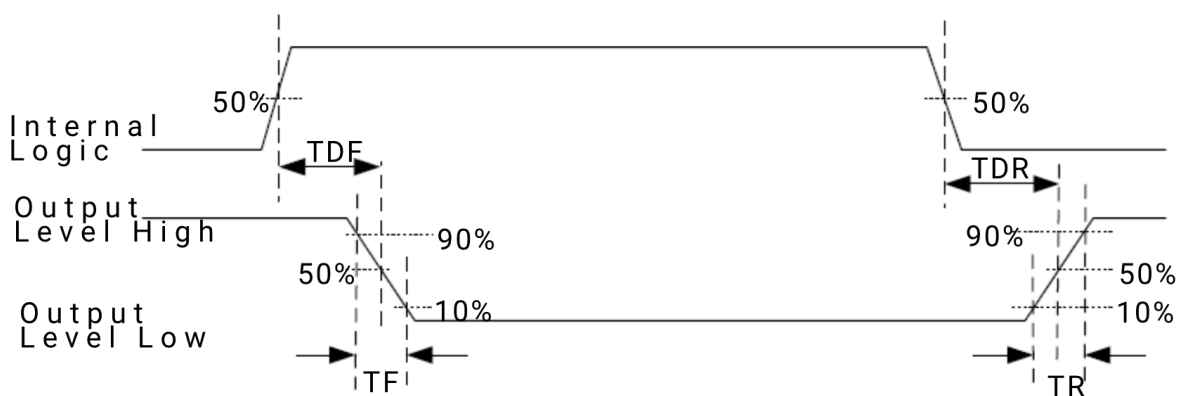

Figure 6-4 Output Logic Level

Table 6-2 Output Electrical Feature

Parameter Name	Symbol	Value
Output Logic Level Low	VL	730 mV
Output Logic Level High	VH	3.2 VDC
Output Falling Delay	TDF	6.3 μ s
Output Rising Delay	TDR	68 μ s
Output Falling Time	TF	3 μ s
Output Rising Time	TR	60 μ s

6.2 I/O Wiring

The device receives an externally input signal or output a signal to an external device through its 12-pin connector. This section introduces how to wire the I/O parts.

Note

Here we take LineIn 0 as an example to introduce input signal wiring, and take LineOut 0 as an example to introduce output signal wiring.

6.2.1 Input Signal Wiring

Note

Input signal wiring may differ by external device types.

PNP Device

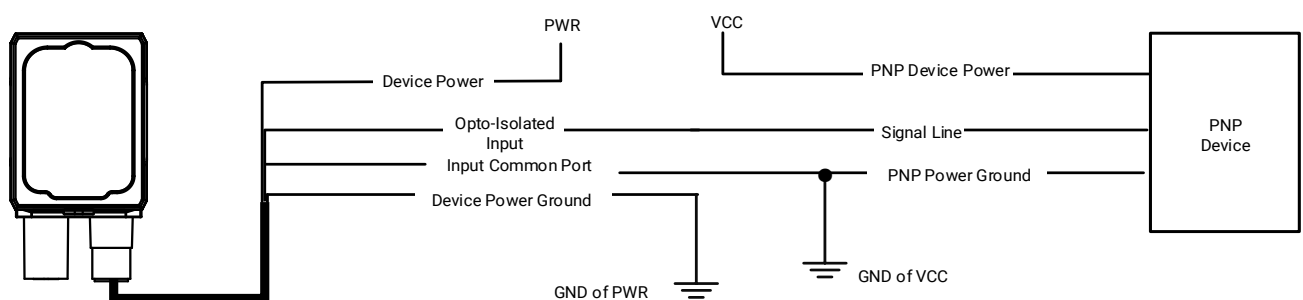

Figure 6-5 Input Signal Connecting to PNP Device

NPN Device

If the VCC of NPN device is 12 VDC or 24 VDC and pull-up resistor is not used, and its wiring is as follows.

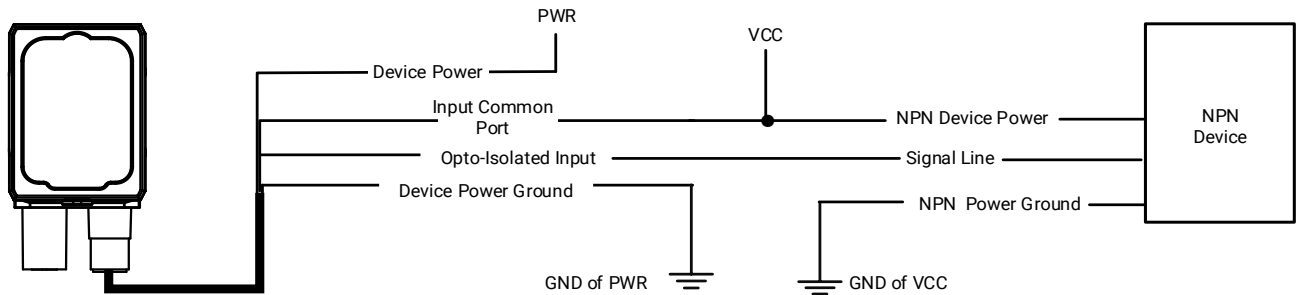

Figure 6-6 Input Signal Connecting to NPN Device without Pull-Up Resistor

If the VCC of NPN device is 12 VDC or 24 VDC and 1 K Ω pull-up resistor is used, its wiring is as follows.

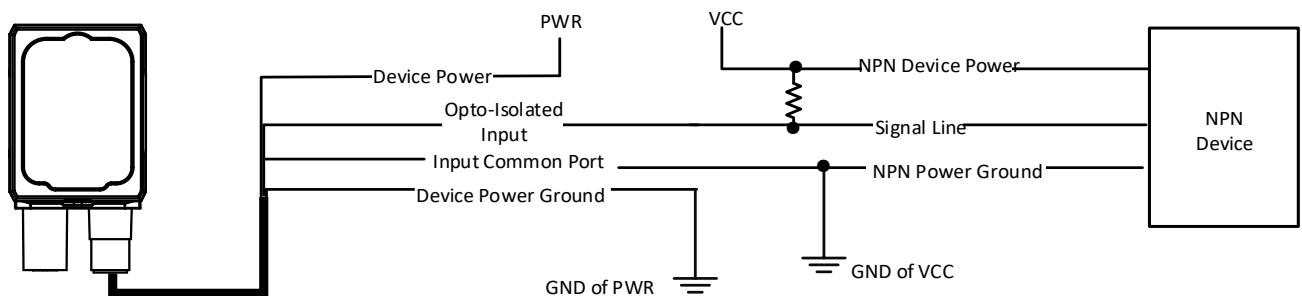

Figure 6-7 Input Signal Connecting to NPN Device with Pull-Up Resistor

6.2.2 Output Signal Wiring

Note

- Output signal wiring may differ by external device types.
- The voltage of VCC should not higher than that of PWR. Otherwise, the device's output signal may have exception.

PNP Device

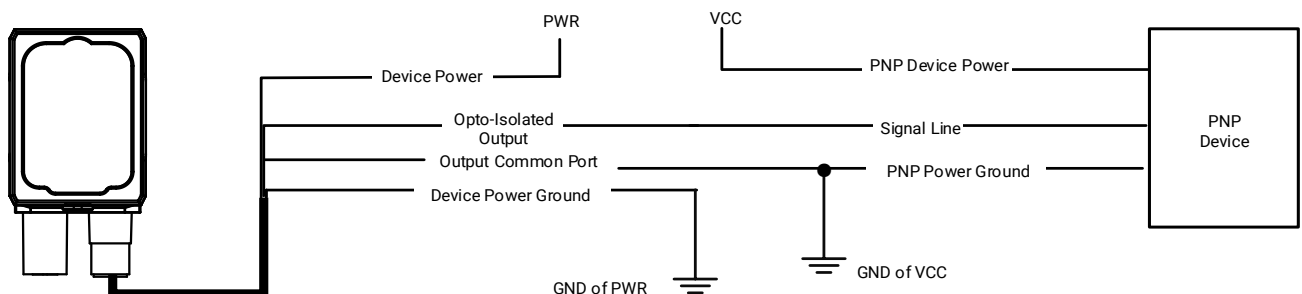

Figure 6-8 Output Signal Connecting to PNP Device

NPN Device

If the VCC of NPN device is 12 VDC or 24 VDC and pull-up resistor is not used, its wiring is as follows.

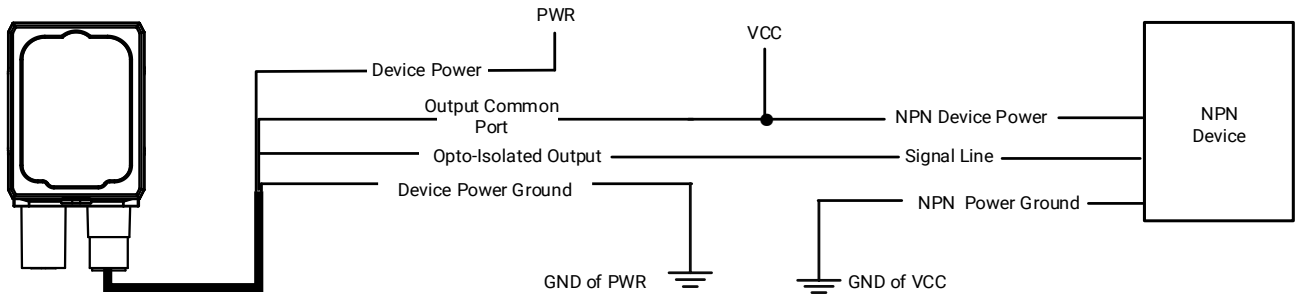

Figure 6-9 Output Signal Connecting to NPN Device without Pull-Up Resistor

If the VCC of NPN device is 12 VDC or 24 VDC and 1 KΩ pull-up resistor is used, its wiring is as follows.

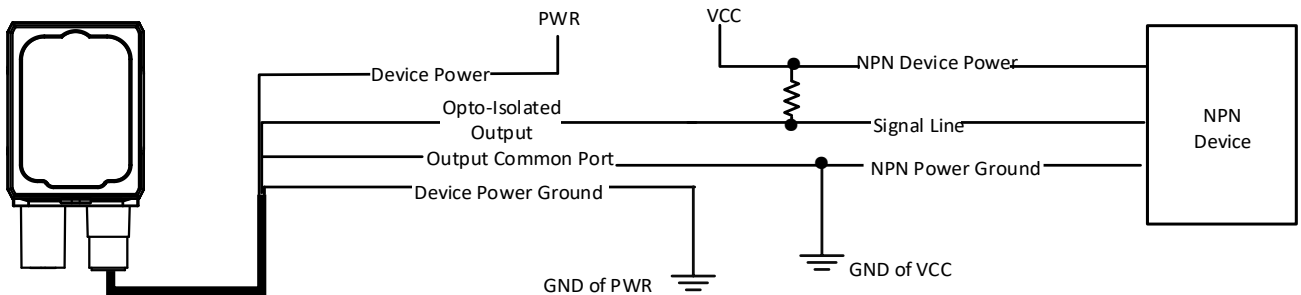

Figure 6-10 Output Signal Connecting to NPN Device with Pull-Up Resistor

6.3 RS-232 Serial Port

The device supports outputting via the RS-232 serial port.

6.3.1 RS-232 Serial Port Introduction

The 9-pin male connector and 25-pin male connector are commonly used serial ports, as shown below. You can refer to the table below for the specific pin name and function.

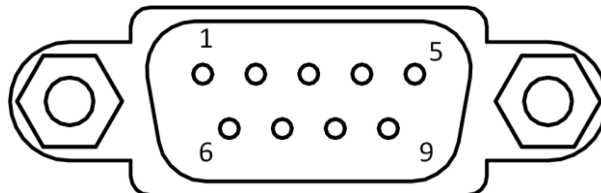

Figure 6-11 9-Pin Connector

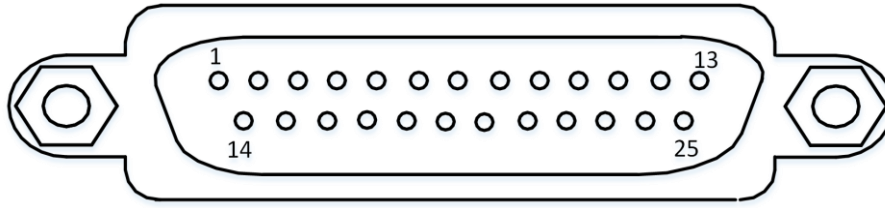

Figure 6-12 25-Pin Connector

Table 6-3 Description

Serial Port Type	Pin No.	Name	Function
9-Pin Connector	2	RX	Receive Data
	3	TX	Transmit Data
	5	GND	Signal Ground
25-Pin Connector	2	TX	Transmit Data
	3	RX	Receive Data
	7	GND	Signal Ground

6.3.2 RS-232 Serial Port Wiring

You can refer to the serial port wiring below to connect the device with an external device.

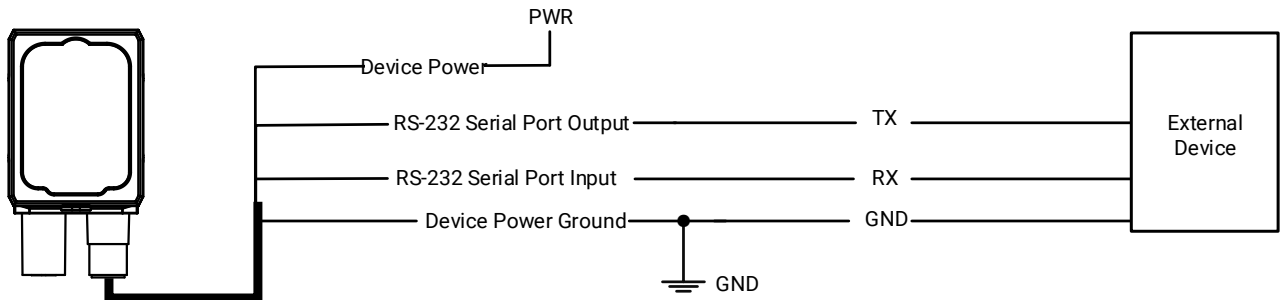

Figure 6-13 RS-232 Serial Port Wiring

Chapter 7 Device Connection

Device connection to the client software is required for device's configuration and remote operations. This section introduces how to install the client software, set PC and device network, connect the device to the client software, etc.

7.1 Install Client Software

IDMVS is a client software for device configuration and remote operations.

Steps

Note

- The client software is compatible with 32/64-bit Windows XP/7/10.
 - You can get the client software installation package from <https://en.hikrobotics.com/>.
 - The graphic user interface may differ by different versions of client software you use.
-

1. Double click the installation package to start installing the client software.
2. Select the language.
3. Read and check **Terms of the License Agreement**.
4. Click **Start Setup**.
5. Select installation directory and click **Next**.

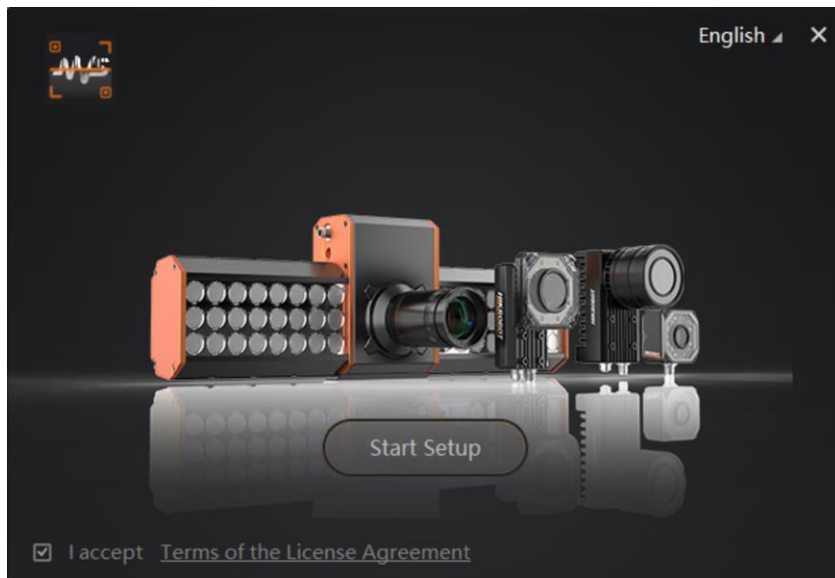

Figure 7-1 Installation Interface

6. Finish the installation according to the interface prompts.

7.2 Set PC Network

To ensure stable image transmission and normal communication between the PC and the device via client software, you need to set the PC network before using the client software.

Note

For different Windows versions, the specific setting path and graphic user interface may differ. Please refer to the actual condition.

Steps

1. Go to PC network settings: **Start** → **Control Panel** → **Network and Internet** → **Network and Sharing Center** → **Change adapter settings**.
2. Select NIC and set the IP obtainment mode.
 - Select **Obtain an IP address automatically** to get an IP address of the PC automatically.
 - Select **Use the following IP address** to set an IP address for the PC manually.
3. Make sure that the PC and the device are in the same network segment.

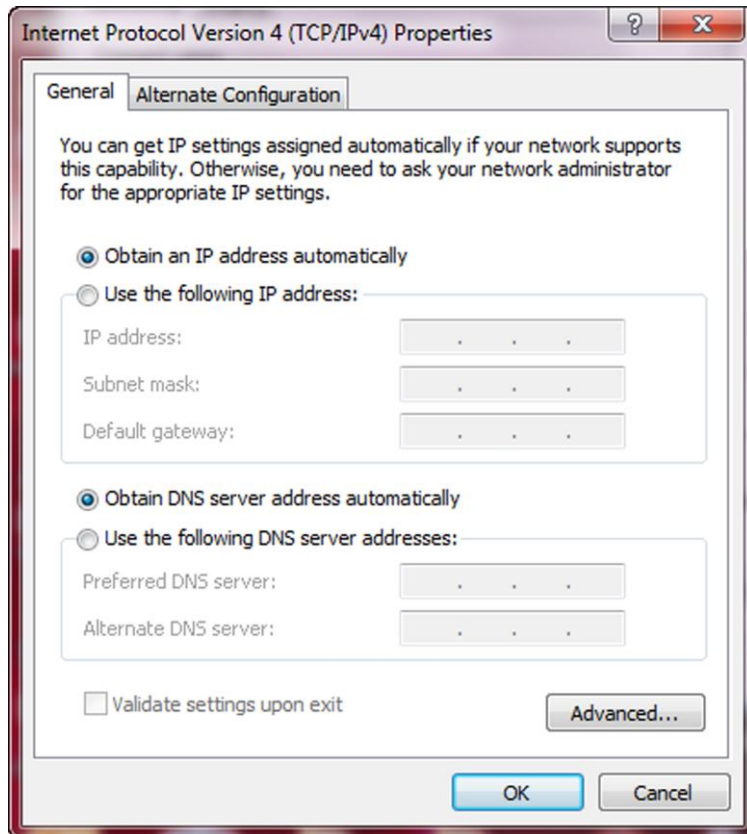



Figure 7-2 Set PC Network

7.3 Set Device Network and Connect to Client Software

You can set and operate the device in the client software only when the device is in the same network segment with the PC where the client software is installed.

Steps

1. Double click the client software to run it.
2. Click  to find the device.
3. Right click the device to be connected, and click **Modify IP**.
4. Set the IP address of the device in the same network segment with the PC, and click **OK**.

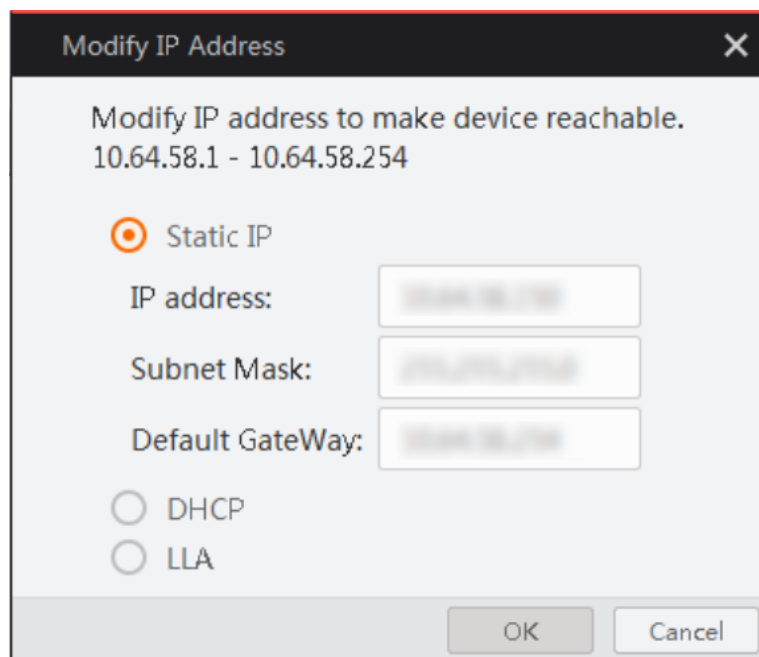

Figure 7-3 Modify IP Address

5. Double click the device in device list or click  to connect it to the client software.

Chapter 8 Basic Operation

8.1 Client Software Layout

The main window of the client software is displayed after the device is connected to the client software.

Note

- The graphic user interface may differ by different versions of client software you use.
- Refer to the user manual of the client software for detailed operation guide.

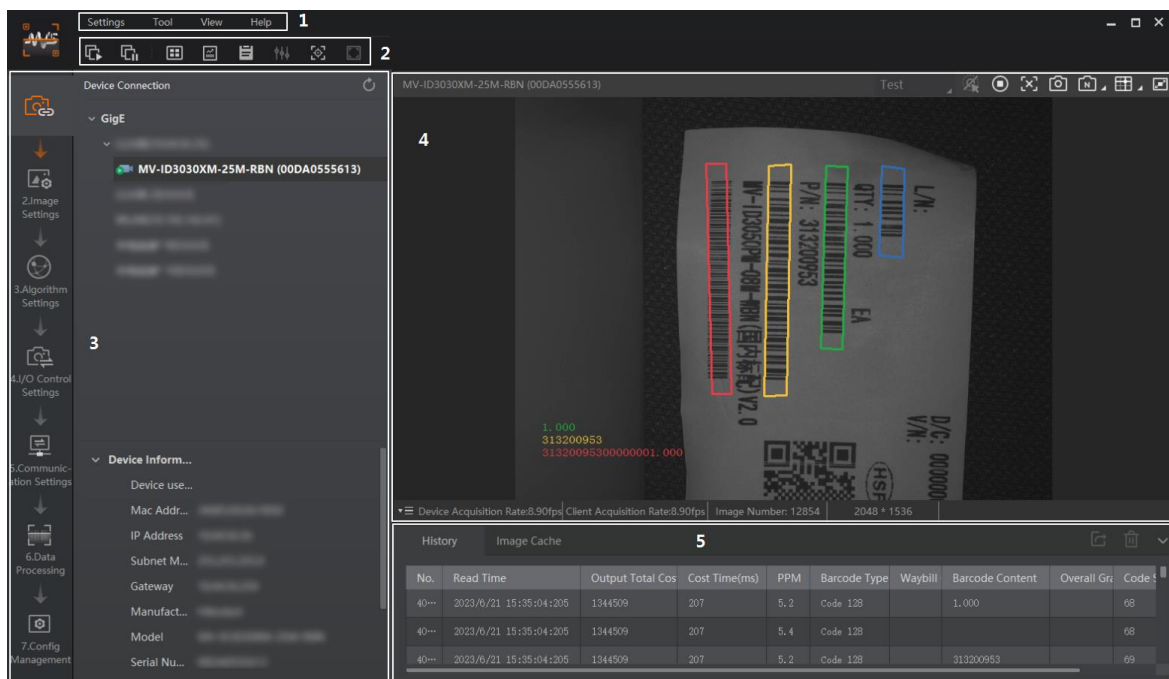

Figure 8-1 Main Window

Table 8-1 Main Window Description

No.	Name	Description
1	Menu Bar	Provides access to function modules including Settings, Tool, View, and Help.
2	Control Toolbar	Provides access to functions such as starting/ending batch acquisition, switching the window division mode, viewing real-time statistics during acquisition, and viewing device logs, and quick access to tools such as Smart Tune, Auto Focus, and SelfAdapt Adjust.

No.	Name	Description
3	Device Configuration Wizard Panel	The wizard for device configurations. In the Device Information field, you can view information about a device and its corresponding network interface. You can connect device(s) to the Software, manage devices by groups, and configure parameters related to image settings, algorithm settings, I/O control settings, communication settings, data processing, and configuration management.
4	Live View Window	Displays the live video of the selected device(s).
5	History Panel	Displays the code reading history of device(s). You can also view the real-time reading results during acquisition.

The device configuration wizard panel and control toolbar help you perform some basic operations of the device.

Table 8-2 Device Configuration Wizard Panel Description

No.	Module Name	Description
1	Device Connection	You can connect or disconnect device, modify device IP address, view device information, etc.
2	Image Settings	You can set image parameters, light parameters, etc.
3	Algorithm Settings	You can add different code type, set code number, etc.
4	I/O Control Settings	You can set parameters related with input and output.
5	Communication Settings	You can select different communication protocols, and set parameters for output result.
6	Data Processing	You can set filter rule for output result.
7	Configuration Management	You can save and load user parameters, and restart the device.

8.2 Basic Operation

Steps

1. Go to the left corner of live view window, and select the operation mode.

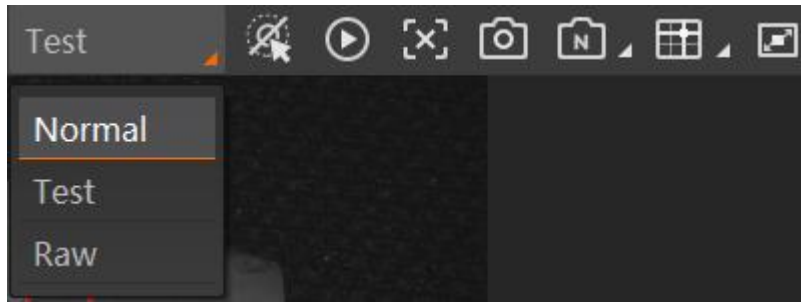

Figure 8-2 Select Operation Mode

Note

Stopping the real-time acquisition is required before selecting the operation mode.

Table 8-3 Operation Mode Description

Device Mode	Description
Test Mode	It is used during device debugging. The device outputs images that are acquired in real-time, and displays code information.
Normal Mode	It is used during device normal operation. After reading code in image, the device outputs image and code information.
Raw Mode	It is used during testing image data. The device outputs raw data and displays code information.

2. Click  in the live view window to view images and the code reading effect.

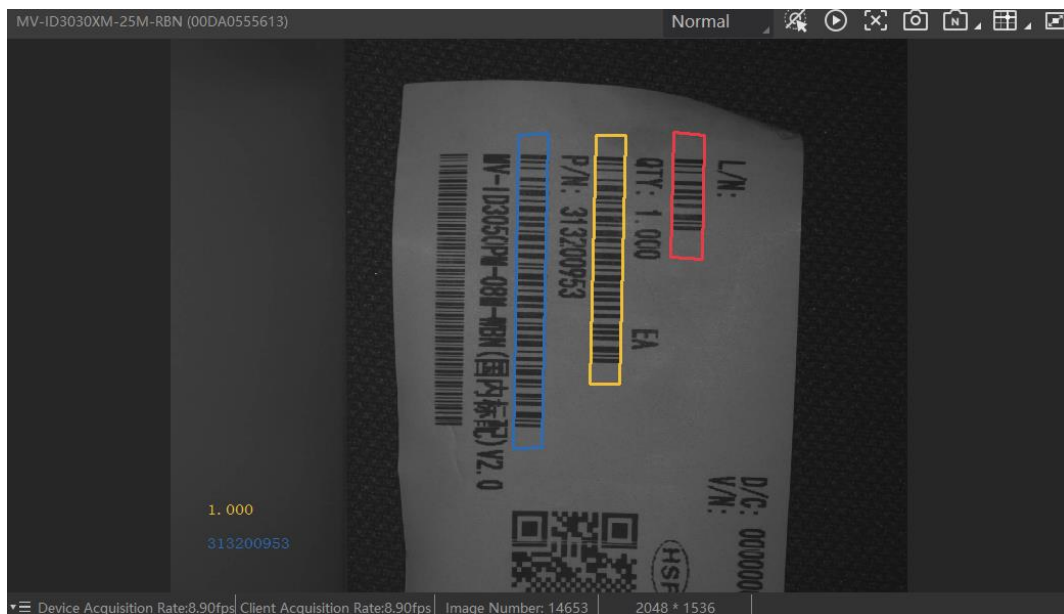





Figure 8-3 Code Reading Effect

3. Click  in the control toolbar to perform smart tune and adjust parameters like exposure, gain, etc. if the code reading effect is not very good.

Note

- Click  if you just want to adjust focus parameters.
 - Click  if you just want to perform self-adaptive adjustment.
-

4. Go to **Algorithm Settings** in configuration wizard panel to add code types accordingly.
5. Go to **I/O Control Settings** to set input and output parameters.
6. Go to **Communication Settings** to select communication protocols and set parameters.
7. (Optional) Go to **Device Connection** to set other parameters of the device accordingly.
8. Go to **Configuration Management** to save and load user sets, or use default settings.
9. (Optional) Go to history panel to view codes recognized by the device.

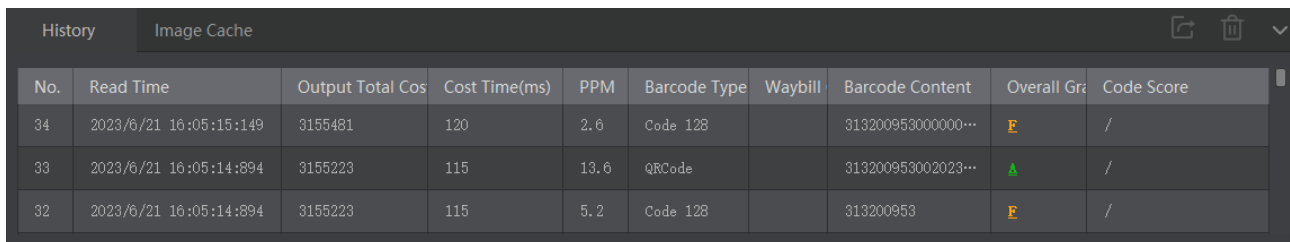

No.	Read Time	Output Total Cos	Cost Time(ms)	PPM	Barcode Type	Waybill	Barcode Content	Overall Gr	Code Score
34	2023/6/21 16:05:15:149	3155481	120	2.6	Code 128		313200953000000...	F	/
33	2023/6/21 16:05:14:894	3155223	115	13.6	QRCode		313200953002023...	A	/
32	2023/6/21 16:05:14:894	3155223	115	5.2	Code 128		313200953	F	/

Figure 8-4 History Record

Chapter 9 Device Settings

9.1 Feature Tree Introduction

After the device is connected to the client software, and you can right click the device in **Device Connection**, and click **Feature Tree**.

 **Note**

The parameters of the feature tree may differ by device models and firmware versions.

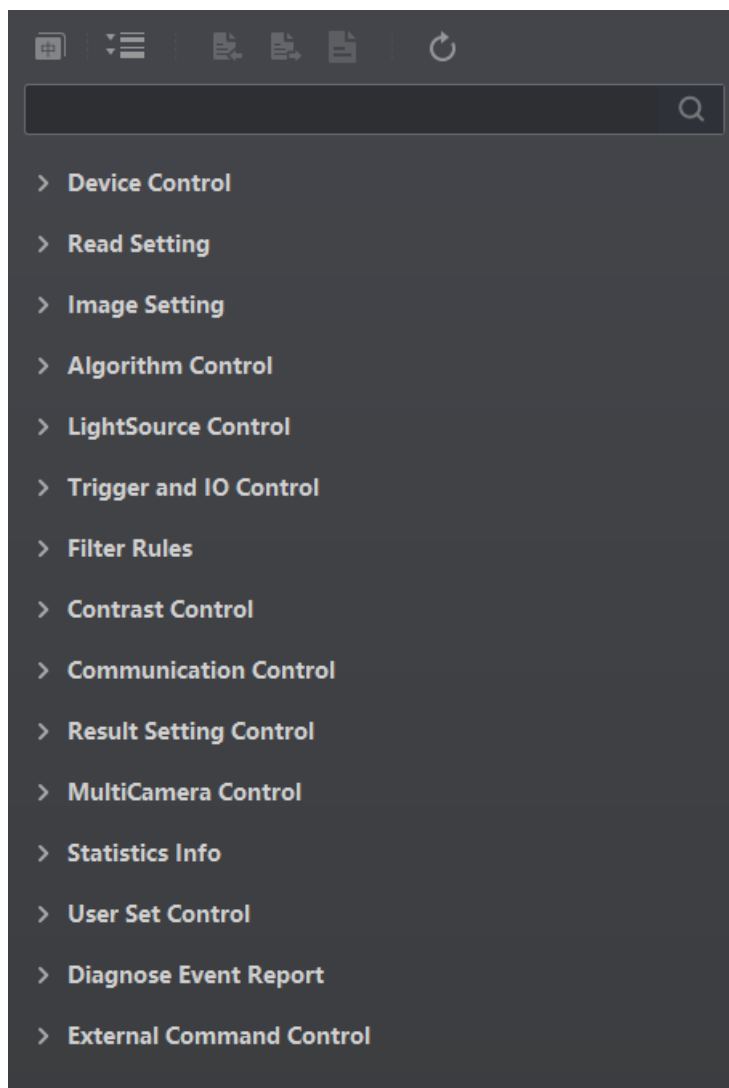

Figure 9-1 Feature Tree

Table 9-1 Feature Tree Description

Name	Description
Device Control	It allows you to view the device's information, edit its name, etc.
Read Setting	It allows you to set the device's operation mode and select code types.
Image Setting	It allows you to set frame rate, exposure, gain, Gamma, etc.
Algorithm Control	It allows you to algorithm parameters.
Light Source Control	It allows you to set the light source's parameters.
Trigger and IO Control	It allows you to set parameters of input and output.
Filter Rules	It allows you to set the filter rule of codes.
Contrast Control	It allows you to compare the data that the device reads with preset data and output contrast result.
Communication Control	It allows you to set parameters related to different communication protocols.
Result Setting Control	It allows you to set parameters of outputted contents.
Multi Camera Control	It allows you to set parameters of multi-camera to let them operate in a collaborative way.
Statistics Info.	It allows you to count data related with code reading.
User Set Control	It allows you to save and load configured user set.
Diagnose Event Report	It allows you to monitor memory and CPU usage rate, and let you know when there is a crash, higher CPU usage rate, insufficient memory, etc.
External Command Control	It allows you to set communication parameters between the device and external devices.

9.2 Image Quality Settings

This section introduces how to set image related parameters of the device via client software.

 **Note**

The specific parameters may differ by device models and firmware versions.

9.2.1 Set Image Parameters

You can set parameters like exposure time, gain, Gamma, acquisition frame rate, acquisition burst frame count, etc. in **Image Settings** area.

Table 9-2 Set Image Parameters

Name	Description
Exposure Time	<p>You can increase exposure time to improve image brightness.</p> <p>Note</p> <p>To some extent, increasing exposure time will reduce acquisition frame rate, and impact image quality.</p>
Gain	<p>You can increase gain to improve image brightness.</p> <p>Note</p> <p>To some extent, increasing exposure time will reduce acquisition frame rate, and affect image quality.</p>
Gamma	<p>Gamma allows you to adjust the image contrast. It is recommended to reduce Gamma to increase brightness in dark background.</p>
Acquisition Frame Rate	<p>Acquisition frame rate refers to the image number that is acquired by the device per second.</p>
Acquisition Burst Frame Count	<p>Acquisition burst frame count refers to the outputted image number when the device is triggered once.</p>
Polling Enable	<p>It enables the polling function, you can select off, single or multiple mode.</p> <p>Note</p> <p>The parameter of polling enable will be displayed only when the trigger mode is on.</p>

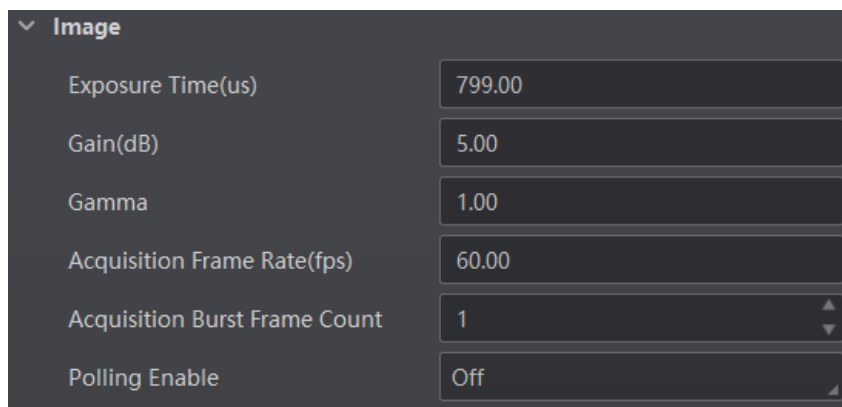

Figure 9-2 Set Image Parameters

9.2.2 Set Exposure

The device supports three types of exposure modes, including off, once, and continuous. Refer to the table below for details.

Table 9-3 Exposure Mode

Exposure Mode	Description
Off	The device exposures according to the value configured by the user in Exposure Time (μs) .
Once	The device adjusts the exposure time automatically according to the image brightness. After adjusting once, the device will switch to off mode.
Continuous	The device adjusts the exposure time continuously according to the image brightness.

Steps

1. Right click the device in **Device Connection**, and click **Feature Tree**.
2. Go to **Image Setting**, and select **Once** or **Continuous** as **Exposure Auto** according to actual demands.
3. Select **Global** or **Partial** as **Exposing Area** according to actual demands.
4. (Optional) Set specific exposure area if **Partial** is selected.
 - Area Width: It refers to the horizontal resolution in partial exposure area.
 - Area Height: It refers to the vertical resolution in partial exposure area.
 - Offset X: It refers to the horizontal coordinate of upper left corner in partial exposure area.
 - Offset Y: It refers to the vertical coordinate of upper left corner in partial exposure area.

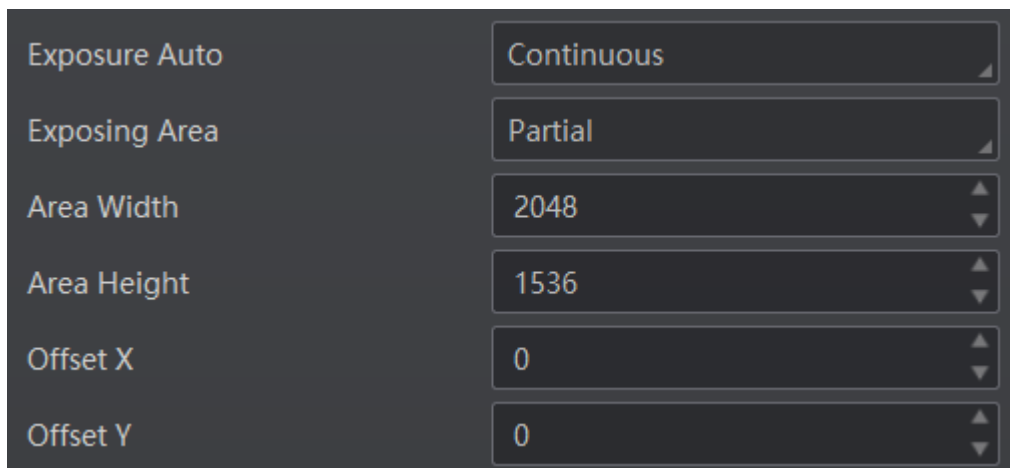

Figure 9-3 Set Exposure

9.2.3 Set Gain

The device supports three types of gain modes, including off, once, and continuous. Refer to the table below for details.

Table 9-4 Gain Mode

Gain Mode	Description
Off	The device adjust gain according to the value configured by the user in Gain (dB) .
Once	The device adjusts gain automatically according to the image brightness. After adjusting once, the device will switch to off mode.
Continuous	The device adjusts gain continuously according to the image brightness.

Steps

1. Right click the device in **Device Connection**, and click **Feature Tree**.
2. Go to **Image Setting**, and select **Once** or **Continuous** as **Gain Auto**.

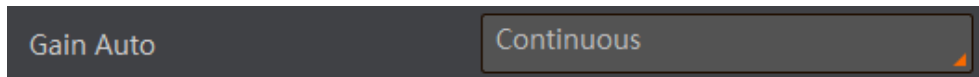

Figure 9-4 Set Gain

9.2.4 Set Polling

The polling function allows the device to acquire images based on the parameters you set, including exposure time, gain, Gamma, light source, focus position, etc. Currently, two types of polling modes are available, including single mode and multiple mode.

Note

- Stopping the real-time acquisition is required before setting the polling function.
- After the polling enabled, the device acquires images with its max. frame rate. Once the polling disabled, the frame rate you set in **Acquisition Frame Rate** takes effect.
- The polling function and specific parameters may differ by device models.
- The specific parameters of polling may differ by device models.

Single Mode

Before You Start

- Make sure the trigger mode is opened and the trigger source is not the brightness before setting the polling function.

Note

The brightness trigger source and the polling function cannot be used at the same time.

- It is recommended to use the polling function under the normal operation mode, and test/raw modes are used for debugging only.

Steps

1. Right click the device in **Device Connection**, and click **Feature Tree**.
2. Go to **Image Setting** → **Polling Mode**, and select **Single** as **Polling Enable**.
3. Select one parameter (e.g. **Param1**) from **Polling Param**.

Note

Up to 8 sets of parameter can be selected from **Polling Param**.

4. Set parameters participating the polling like **Polling Exposure Time**, **Polling Gain**, **Polling Gamma**, etc. according to actual demands.

Table 9-5 Parameters of Single Mode Polling

Parameter	Description
Polling Exposure Time	It sets the exposure time of polling.
Polling Gain	It set the polling gain.
Polling Gamma	It sets the polling Gamma value. <ul style="list-style-type: none"> ● If the value is between 0 and 1, when the image brightness increases, dark area becomes brighter. ● If the value is between 1 and 4, when the image brightness decreases, dark area becomes darker.
Polling Focus Enable	After enabling this parameter, you can set polling focus position.
Polling Focus Position	It sets the polling focus position.
Polling Lighting Selector	It selects lamps on different directions, including up/down and mid.
Polling Lighting Enable	After enabling this parameter, the light source will turn on.

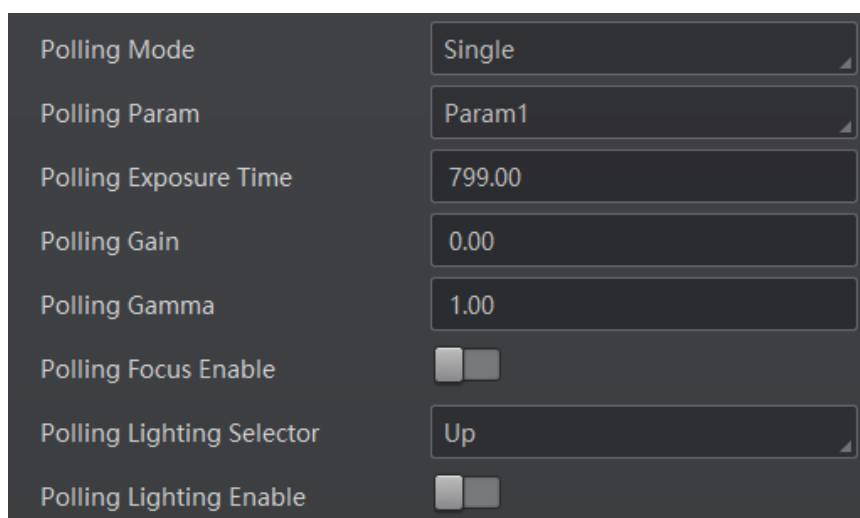

Figure 9-5 Single Mode

Multiple Mode

Note

- In multiple mode, the device supports trigger parameters like software trigger, external trigger, etc., does not support stopping polling via the external trigger.
- The rule for multiple-mode polling is that the polling is started from the polling parameter with Best Polling Group Idx, and then execute other polling parameters you selected in turn. For example, if the Param3 is the Best Polling Group Idx and Param1, Param2, Param4 and Param5 are enabled, the polling order is Param3 > Param1 > Param2 > Param4 > Param5.

Before You Start

- Make sure the trigger mode is opened and the trigger source is not the brightness before setting the polling function.

Note

The brightness trigger source and the polling function cannot be used at the same time.

- It is recommended to use the polling function under the normal operation mode, and test/raw modes are used for debugging only.

Steps

1. Right click the device in **Device Connection**, and click **Feature Tree**.
2. Go to **Image Setting** → **Polling Mode**, and select **Multiple** as **Polling Enable**.
3. Set **Polling Time** and **Polling Period** according to actual demands.
 - **Polling Time** is used to determine whether the polling is finished or not, and it ranges from 100 to 2147482.
 - **Polling Period** is whole period from Param1 to Param8, and it ranges from 1 to 5000.
4. Select 2 to 8 sets of parameters (e.g. **Param1** and **Param2**) from **Polling Param**, and enable **Polling Param Enable** to let them take effect.
5. Set parameters participating the polling like **Polling Exposure Time**, **Polling Gain**, **Polling Gamma**, etc. according to actual demands.

Table 9-6 Parameters of Multiple Mode Polling

Parameter	Description
Polling Exposure Time	It sets the exposure time of polling.
Polling Gain	It set the polling gain.
Polling Gamma	It sets the polling Gamma value. <ul style="list-style-type: none"> • If the value is between 0 and 1, when the image brightness increases, dark area becomes brighter. • If the value is between 1 and 4, when the image brightness decreases, dark area becomes darker.

Parameter	Description
Polling Focus Enable	After enabling this parameter, you can set polling focus position.
Polling Focus Position	It sets the polling focus position.
Polling Lighting Selector	It selects lamps on different directions, including up/down and mid.
Polling Lighting Enable	After enabling this parameter, the light source will turn on.

6. Repeat step 4 and step 5 to set other parameters from **Polling Param**.

7. (Optional) View **Polling Status** and **Best Polling Group Idx**.

- **Polling Status**: It displays the current polling status. 0 stands for polling ended, and 1 stands for polling started.
- **Best Polling Group Idx**: It is used to display the polling parameter number when the device recognizes codes after enabling polling. If the polling is disabled or polling parameters are edited, it displays 1 by default.

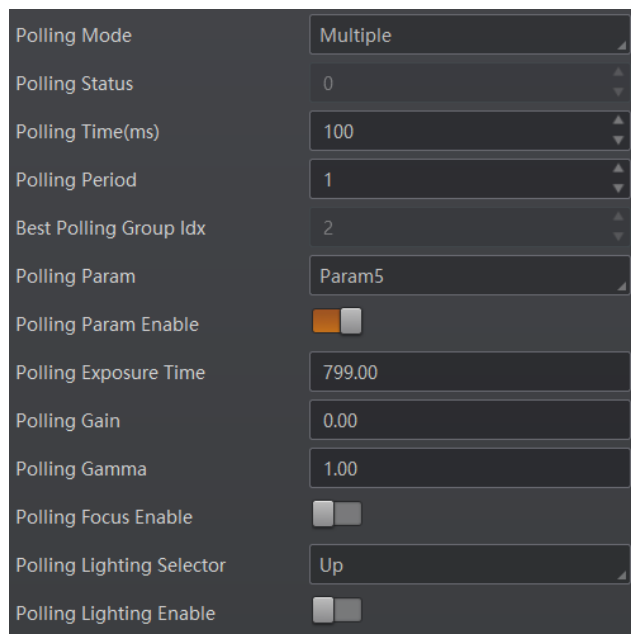

Figure 9-6 Multiple Mode

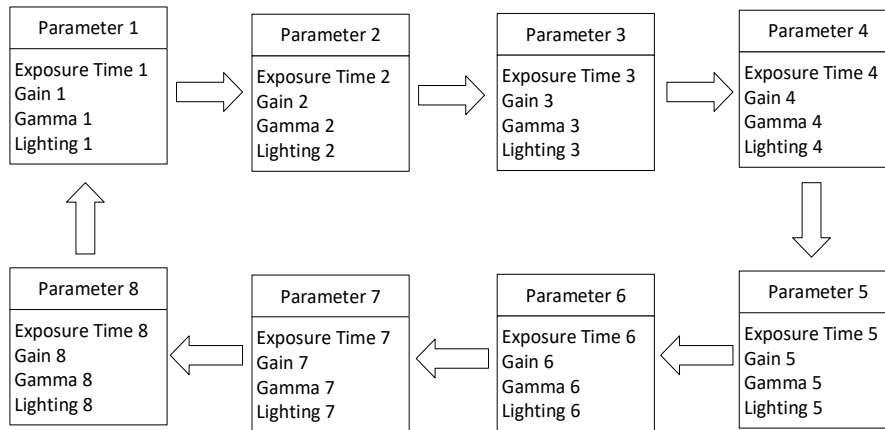

Figure 9-7 Polling Diagram

9.2.5 Set Light Source

Light source control allows you to enable the device’s aiming system and light source, and set related parameters according to actual demands.

Steps

- Go to **Image Settings** → **Light**, and select **Aiming Light Enable**.
 - **Off** means that the aiming light is turned off.
 - **Strobe** means that the aiming light is turned on if the device is acquiring images and the aiming light is turned off if the device is not acquiring images.
 - **Strobe Long** means that the aiming light is used when the device is powered on.
- Click lamps on the light source illustration to turn on or turn off lamps on different directions.

Note

The lowest LED lamp cannot be turned on if the upper and middle LED lamps are on.

- Select **Lighting Mode** according to actual demands.
 - **Strobe** means the light flashes at a specific interval.
 - **Long** means the light is solid.

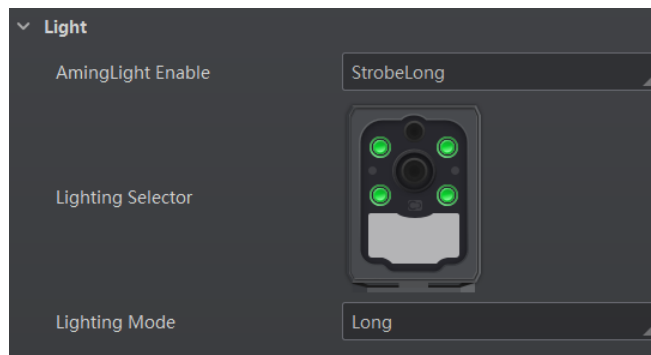

Figure 9-8 Set Light Source

9.2.6 Set Smart Tune

The smart tune function allows you to adjust the device's focus position, exposure, gain, etc. by one-key operation, and supports self-adaptive adjustment.

The smart tune function has two methods to be realized, including smart tune by pressing tune button and smart tune via the client software.

Smart Tune by Pressing Tune Button

Note

- The parameters of the smart tune may differ by device models and firmware versions.
 - During the process of smart tune, the focus parameters and self-adaptive parameters will be adjusted in turn.
-

Steps

1. Go to **Image Settings**, click **All Features** on the right corner, and find **Smart Tune Control**.
2. Enable **Button Tune**, and disconnect the device from the client software.

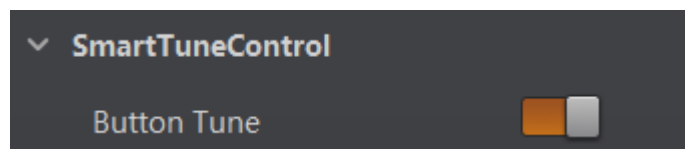

Figure 9-9 Button Tune

Note

Smart tune by pressing the tune button is not supported if the device is connected via the client software.

3. Hold the tune button for 2 sec and the device starts smart tune.
4. (Optional) Hold the button for 2 sec again during smart tune process, and the smart tune will be cancelled.

Smart Tune via Client Software

Apart from pressing tune button to realize smart tune, you can also configure parameters via the client software to realize it.

Before You Start: Make sure that the device is not in trigger mode, and its operation mode is test.

Steps

1. Go to **Image Settings**, click **All Features** on the right corner, and find **Smart Tune Control**.

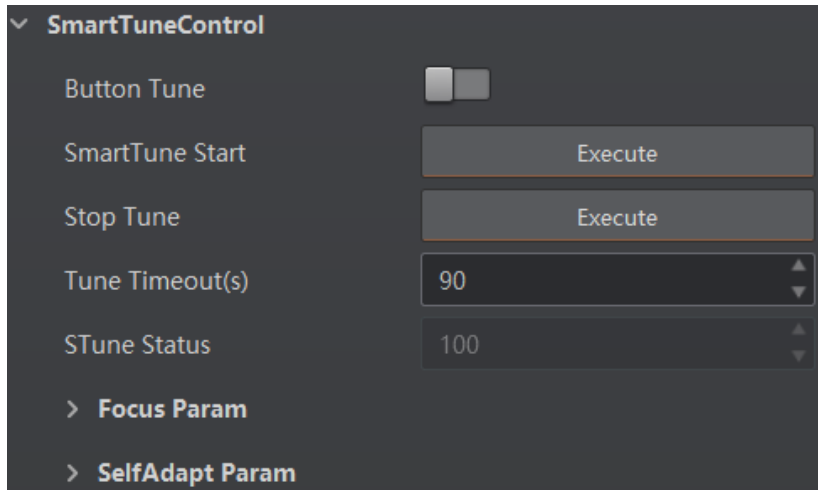

Figure 9-10 Smart Tune Control

- (Optional) Set **Tune Timeout**. If the self-adaptive adjustment exceeds configured value, and it will stop automatically.
- Click **Execute** in **Smart Tune Start** to let the device start smart tune, and a window of smart tune will be displayed for you to view the effect.

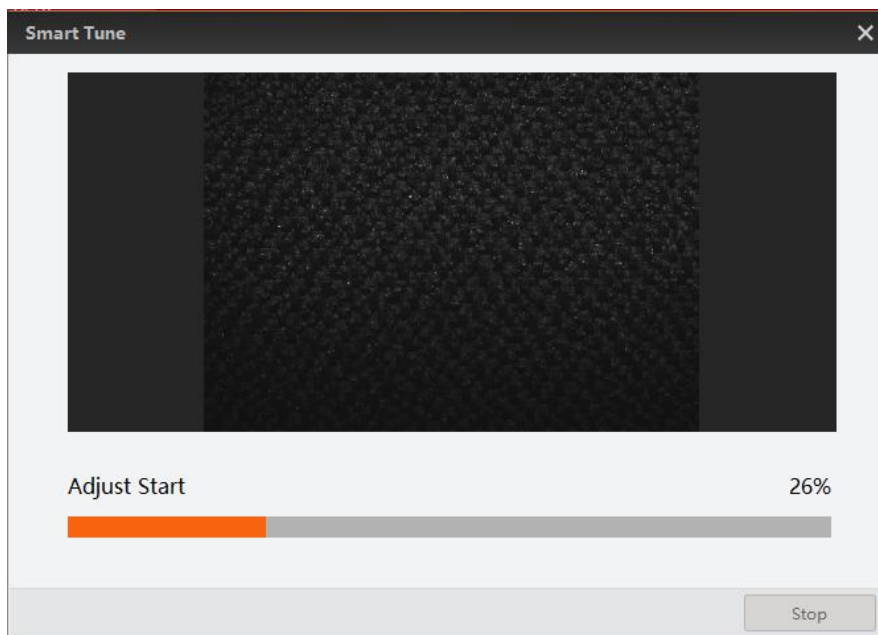

Figure 9-11 Smart Tune Start

- (Optional) View smart tune process via **Smart Tune Status**.
- Click **Execute** in **Stop Tune** to stop smart tune process.

9.2.7 Set Auto Focus

The device supports the auto focus function according to the code position in the field of

view. Currently, two types of auto focus are supported, including global focus and ROI focus.

Note

Make sure that the device's operation mode is test before performing focus, and switch to the normal operation mode after the focus is completed.

Global Focus

The global focus allows you to adjust lens focus in a global field of view just by once.

Steps

1. Go to **Image Settings** → **Smart Tune Control** → **Focus Param** → **Focus Mode Selector**, and select **Whole Area Focus** as **Focus Mode Selector**.

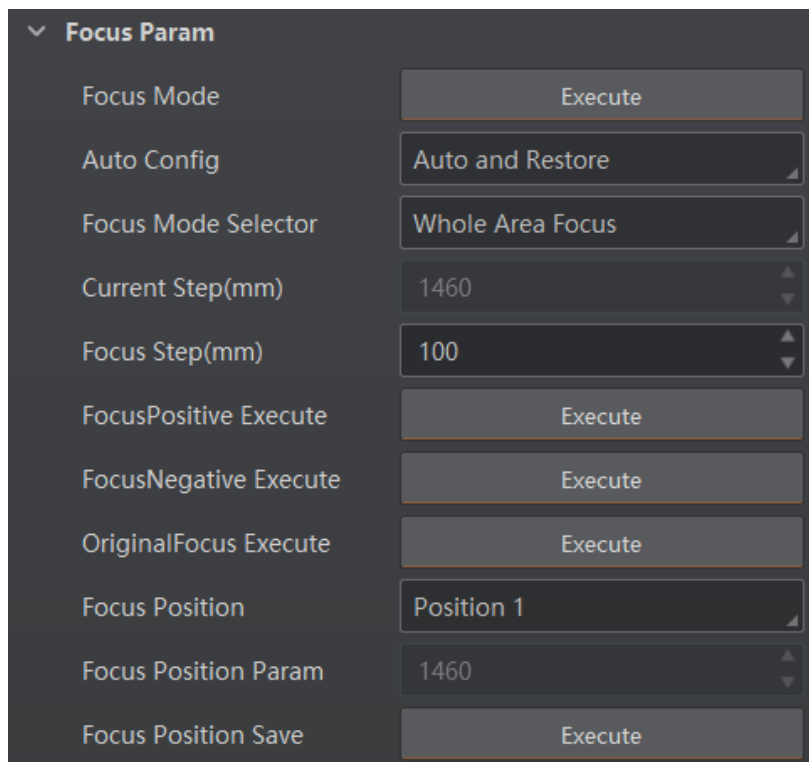



Figure 9-12 Global Focus

2. Click  in the live view window, and click it again to stop acquisition and make sure there is an image in the window.
3. Select the focus mode in **Auto Config**:
 - **Full Auto**: In this mode, the device will automatically change parameters like focus position, exposure, gain, Gamma and light source when adjusting focus.
 - **Motor Only**: In this mode, the device will change focus position only when adjusting focus.
 - **Auto and Restore**: In this mode, the device will automatically change parameters like focus position, exposure, gain, Gamma and light source when adjusting focus, and keep focus position and restore other parameters after completing focus adjustment.

4. Click **Execute** in **Focus Mode**, and the device starts to adjust focus automatically.

Note

Focus related parameters cannot be configured during auto focus process, and after the process, parameters can be configured again.

5. (Optional) Select the position parameter from **Focus Position**, and click **Execute** in **Focus Position Save** to save the focus position after adjusting focus.

ROI Focus

The ROI focus allows you to adjust lens focus regarding the ROI area by drawing specific area.

Note

The ROI focus is applicable to the scenario where multiple codes with different depth of fields are existed.

Steps

1. Go to **Image Settings** → **Smart Tune Control** → **Focus Param** → **Focus Mode Selector**, and select **ROI Area Focus** as **Focus Mode Selector**.

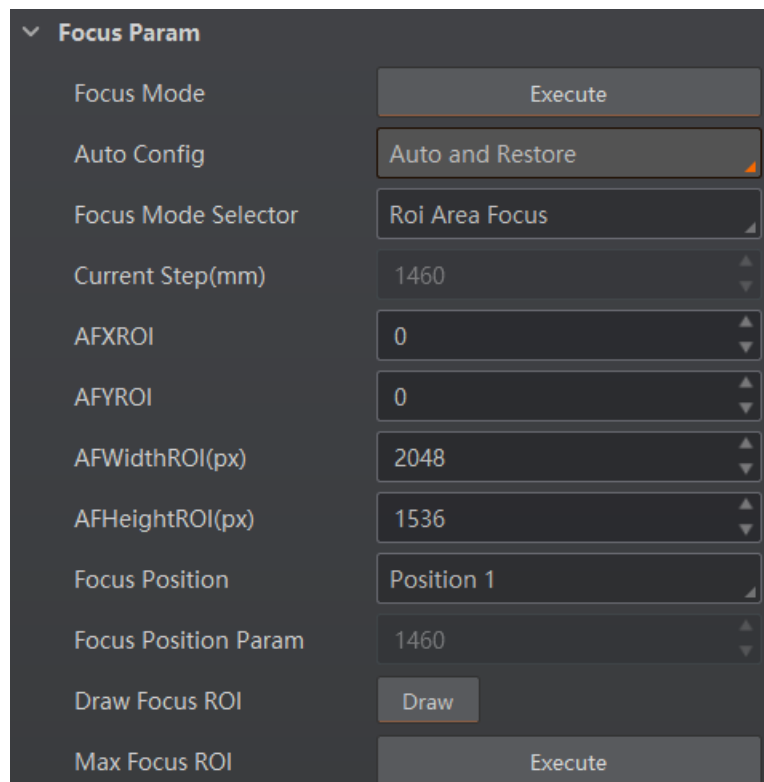



Figure 9-13 ROI Focus

2. Click  in the live view window, and click it again to stop acquisition and make sure there is image in the window.
3. Click **Draw** in **Draw Focus ROI**, and draw ROI by dragging the mouse in live view window.

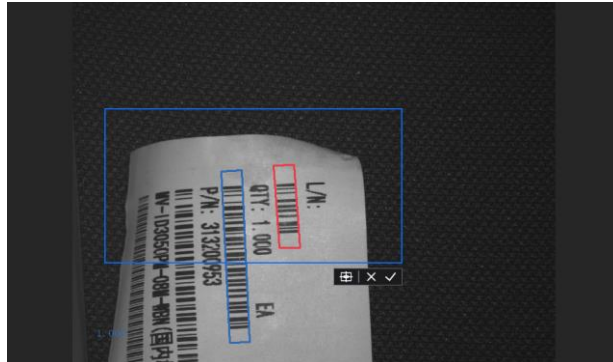

Figure 9-14 Draw Focus ROI

4. (Optional) Set following parameters to adjust ROI size and position.
 - **AF Offsex X**: It is X coordinate of the upper left corner in ROI where executes auto focus.
 - **AF Offsex Y**: It is Y coordinate of the upper left corner in ROI where executes auto focus.
 - **AF Width ROI**: It refers to the width in ROI where executes auto focus.
 - **AF Height ROI**: It refers to the height in ROI where executes auto focus.
5. (Optional) Click **Execute** in **Max. Focus ROI** to have a global focus.
6. (Optional) Repeat step 3 if you want to set multiple ROIs.

9.2.8 Set Fast Focus

The device with liquid lens and ToF function is able to achieve fast focus and is suitable for the scene with the focus speed requirement. In the mobile scene, the device can adjust focus in real time according to the depth of field of the object.

Note

Only device with liquid lens and ToF function supports fast focus settings.

Steps

1. Right click the device in **Device Connection**, and click **Feature Tree**.
2. Go to **Focus Param**, and enable **Fast Focus Enable**.
3. Set **ToF Tolerance** to ToF fast focus distance threshold.

Note

The device starts adjusting focus when ToF changing range exceeds configured **ToF Tolerance**.

4. View current ToF distance via **ToF Distance**.

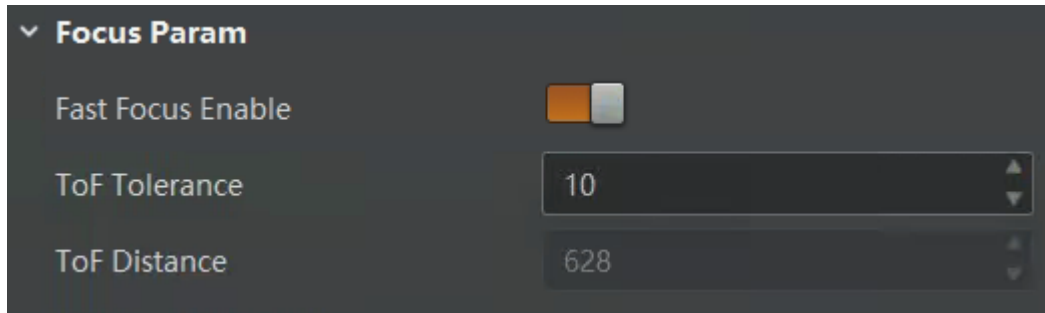

Figure 9-15 Set Fast Focus

9.2.9 Set Self-Adaptive Adjustment

The function of self-adaptive adjustment can automatically adjust exposure, gain, Gamma and other parameters to have a better code reading effect.

Steps

1. Go to **Image Settings** → **Smart Tune Control** → **Self Adapt Adjust**, and unfold **Self Adapt Adjust**.
2. Select **Adjust Source** according to actual demands.

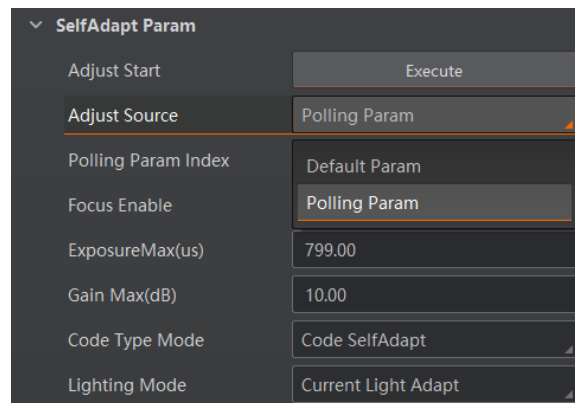

Figure 9-16 Select Adjust Source

- **Default Param:** It adjusts the default parameters.
- **Polling Param:** It adjusts parameters configured in polling. After **Polling Param** is selected as **Adjust Source**, you should select a polling parameter group from **Polling Param** and enable or disable **Focus Enable**.

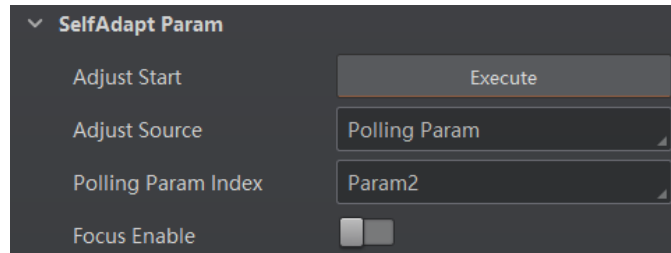

Figure 9-17 Polling Parameter

3. Set **Exposure Max** or **Gain Max** according to actual demands.
 - **Exposure Max**: It sets the max. exposure during the self-adaptive adjustment.
 - **Gain Max**: It sets the max. gain during the self-adaptive adjustment.
4. (Optional) Set self-adaptive code type in **Code Type Mode**.
 - **Code Self-Adaptive**: All code types added in field of view will be self-adaptive.
 - **1D Code**: 1D code types added in field of view will be self-adaptive.
 - **2D Code**: 2D code types added in field of view will be self-adaptive.
 - **Stacked Code**: Stacked code types added in field of view will be self-adaptive.
5. (Optional) Set light source parameters in **Lighting Mode**.
 - **Light Adapt**: The client software will select the best one from all lighting options during the self-adaptive adjustment.
 - **Current Light Adapt**: The client software will use the current configured light source.
 - **All Light Disable**: All light sources will be turned off during self-adaptive adjustment process.
6. Click **Execute** in **Adjust Start**. The device will automatically acquire images and perform self-adaptive adjustment, and stop acquisition after adjustment is completed.

Note

If the adjustment completed, the client software displays the spent time and prompts adjustment succeeded. If the adjustment failed or is timeout, the client software prompts adjustment failure or timeout.

9.2.10 Set Mirror X

The device supports the mirror X function. If this function is enabled, the image will be reversed in a horizontal way.

Go to **Image Settings**, click **All Features** to display **Other Features**, and set **Mirror X** according to actual demands.

Note

This function is enabled by default, and it may differ by device models.

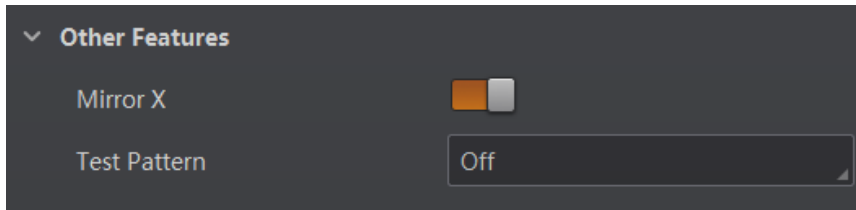

Figure 9-18 Set Mirror X

9.2.11 Set Test Pattern

Test pattern helps troubleshooting image problems and images in the test pattern are only for test. When exceptions occur in images acquired by the device in real time, you can check if images in the test pattern have similar problems to determine the cause of an exception.

 **Note**

- The test pattern is available in the test or raw operation mode.
 - Specific parameters of this function may differ by device models.
-

Go to **Image Settings**, click **All Features**, find **Test Pattern** in **Other Features**, and set **Test Pattern** according to actual demands.

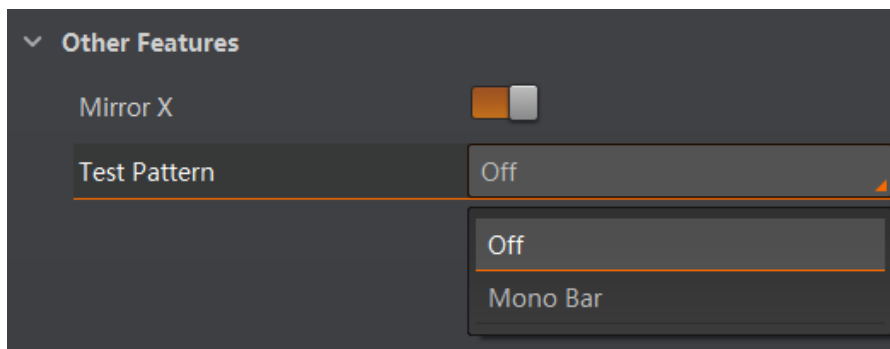

Figure 9-19 Set Test Pattern

9.3 Code Algorithm Settings

The code reader supports reading multiple types of 1D code, 2D code, and stacked codes, and you can add and set code parameters via the client software.

9.3.1 Add Code

Adding code before you set code parameters via the client software. In **Algorithm Settings**, you can add different types of codes according to actual demands.

In **Algorithm Settings**, click **Add Barcode**, select types of codes to be read, and set the **1D**

Code Number, 2D Code Number, and Stack Bar Number according to actual demands.

Note

- For different models of the device, the specific parameters may differ, and the actual device you purchased shall prevail.
- Selected symbology amount and added code amount may affect the code recognition time. Note that selecting more symbologies or adding more codes may consume more time to recognize codes in the image.
- No matter 1D code, 2D code or stacked code number, up to 20 codes can be added at a time. Note that adding more codes may consume more time to recognize codes in the image. Therefore, the code number is recommended to be set according to the actual demands.
- The code reader may output actual code number when the mismatch between the actual code number and the code number set in the client software occurs.



Figure 9-20 Add Codes

9.3.2 Set Code Reading ROI

Algorithm ROI (Region of Interest) allows the device to execute algorithms and read codes on the specific area you selected, and thus improving code reading efficiency.

Currently, multiple ROIs can be configured, and the device outputs codes according to the

number of ROI (e.g. Region 1, Region 2, and Region 3...) in turn. The client software supports drawing single group of ROI and drawing ROI via chessboard.

Note

- If no code is recognized in the algorithm ROI, and the device will output “noread”.
 - Before drawing ROIs, make sure that there are images in the live view window after stopping preview.
 - If no algorithm ROI is enabled, and the full screen is the algorithm ROI by default.
 - This function may differ by device models.
-

Draw Single Group of ROI

Steps

1. Go to **Algorithm Settings**, and find **Algorithm ROI**.
2. Click **Draw** in **Draw ROI** to draw ROI in the live view window.



Figure 9-21 Draw ROI

3. (Optional) Repeat the above step to draw multiple ROIs according to actual demands.
-

Note

The client software only parse codes in the ROI you drawn.

4. (Optional) Set other ROI parameters according to actual demands.
 - **ROI Index:** It indicates different ROIs and ranges from 0 to 149 corresponds 1 to 150 ROIs.
 - **Algo Region Left X:** It refers to the X coordinate of the upper left corner in algorithm ROI.
 - **Algo Region Left Y:** It refers to the Y coordinate of the upper left corner in algorithm ROI.
 - **Algo Region Width:** It refers to the width in algorithm ROI.
 - **Algo Region Height:** It refers to the height in algorithm ROI.
 5. (Optional) Click **Execute** in **Restore Max. Algorithm ROI** to restore the ROI to the full screen.
 6. (Optional) Click **Execute** in **Clear All ROI** to delete all ROIs.
-

Draw ROI via Chessboard

Steps

1. Go to **Algorithm Settings**, and find **Algorithm ROI**.
2. Click **Execute** in **Chessboard ROI**, set parameters, and click **OK** after setting.

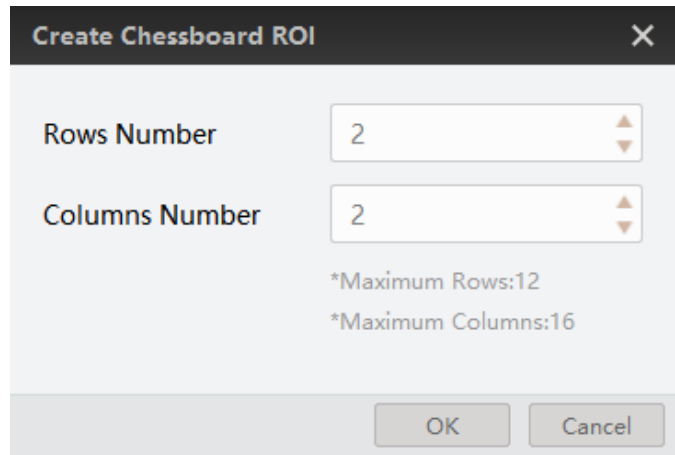

Figure 9-22 Create Chessboard ROI

3. Click after creating ROI, and the red frame becomes green as shown below.

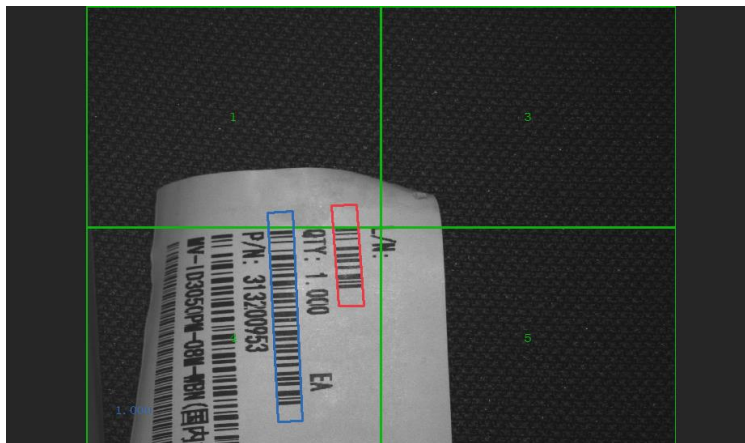

Figure 9-23 Draw ROI via Chessboard

4. (Optional) Click to restore the ROI to full screen, and click to clean all ROIs.
5. Repeat other optional steps mentioned in drawing single group of ROI.

Note

The figures above are for reference only, and refer to the actual conditions.

9.3.3 Set Algorithm Parameter

In **Algorithm Parameter**, select **1DCode**, **2DCode** or **Stacked Code** as **Arithmetic Type**, and

then you can set its corresponding parameters.

Note

- You should have selected at least one type of 1D code, 2D code or stacked code.
 - For different models of the device, the specific parameters may differ, and the actual device you purchased shall prevail.
-

Set 1D Code

- **Code Color:** It defines the readable code color. **White Code On Black Wall** means that the client software can recognize the white code with black background. **Black Code On White Wall** means that the client software can recognize the black code with white background. **Adaptive** means that the client software can recognize both the black code with white background, and the white code with black background.
 - **Code 39 Check:** Enable this parameter if Code 39 uses the parity bit.
-

Note

You need to select **Code 39** in **Add Barcode**.

- **ITF 25 Check:** Enable this parameter if ITF 25 uses the parity bit.
-

Note

You need to select **ITF 25** in **Add Barcode**.

- **1D Code Quality Enable:** If it is enabled, the client software will judge the quality of 1D code and output overall grade. Currently, this parameter is only applicable to Code 39 and Code 128.
- **Code Score Enable:** If it is enabled, the client software will evaluate the code reading environment for 1D code and output code score.

Set 2D Code

- **QR Distortion Correction:** If the QR code or DM code is distorted, you can enable this parameter to improve code recognition rate.
- **DM Code Type:** It includes **All**, **ECC140**, and **ECC200**.
- **2D Code Quality Enable:** If it is enabled, the client software will judge the quality of 2D code and output overall grade. Currently, this parameter is only applicable to DM code and QR code.
- **Code Score Enable:** If it is enabled, the client software will evaluate the code reading environment for 2D code and output code score.

Set Stacked Code

Code Score Enable: If it is enabled, the client software will evaluate the code reading

environment for stacked code and output code score.

9.3.4 Set Code Quality Evaluation

The code quality evaluation function judges the quality of codes and outputs overall grade. Currently, only 1D code and 2D code support code quality evaluation.

 **Note**

- The function of code quality evaluation may differ by device models.
 - In test operation mode, this function is enabled by default. In normal mode, you need to enable it manually.
-

Set 1D Code Quality Evaluation

The 1D quality evaluation function uses the ISO15416 standard to judges the quality of codes and outputs overall grade. Currently, this function is only applicable to Code 39 and Code 128.

Steps

1. Go to **Algorithm Control** → **Algorithm Parameter**, and select **1D Code** as **Arithmetic Type**.
2. Enable **1D Code Quality Evaluation**.
3. Enable different quality evaluation standards according to actual demands.

Table 9-7 Quality Evaluation Standards

Parameter	Description
Decodability	It evaluates whether the code has enough basic information to be decoded.
Symbol Contrast	It evaluates the difference between the max. brightness value and the min. brightness value of the code area.
Modulation	It evaluates the degree of change in terms of brightness.
Edge Determination	It evaluates how well the number of edges read by the code matches the configured number of edges.
Minimum Reflectance	It evaluates the ratio of the min. brightness value to the max. brightness value.
Minimum Edge Contrast	It evaluates the min. value of the reflectivity difference of the strip connecting the spaces.
Decode Enable	It evaluates whether the code recognition is successful or not.
Defects	It evaluates codes or spaces for defects or dirt.
Quiet Zone	It evaluates the quiet zone width of the code meets the specification.

4. Set the evaluation value for A/B/C/D grade according to actual demands.

 **Note**

- If the actual code reading value of the device is greater than the grade A evaluation value, and then the evaluation standard is grade A. If the actual code reading value is between grade A and grade B, and then the evaluation standard is grade B. If the actual code reading value is between grade B and grade C, and then the evaluation standard is grade C. If the actual code reading value is between grade C and grade D, and then the evaluation standard is grade D. If the actual code reading value is lower than the D grade, and then the evaluation standard is F grade.
- The client software selects the worst grade among all the evaluation standards as the grade judgment result of the code. The A grade means that the code quality is best, and F grade means that code quality is worst.

5. Enable **Aperture Enable** and enter **Aperture** according to the smallest size of codes.
6. (Optional) Set **Quality 1D Max Num** to configure the amount of code to be evaluated. If the actual amount of code exceeds the configured, the later codes will not be evaluated.
7. (Optional) Go to **Algorithm Control** → **Rating Standard 1D Enable**, set enable **Rating Standard 1D Enable**, and select **1D Rating Standard**.

 **Note**

For example, if **1D Rating Standard** is **C**, and then the client software will output codes with A/B/C grade and codes with D/F will be filtered.

7. Click  to start acquisition, and the client software will display the overall code quality in the history record area.

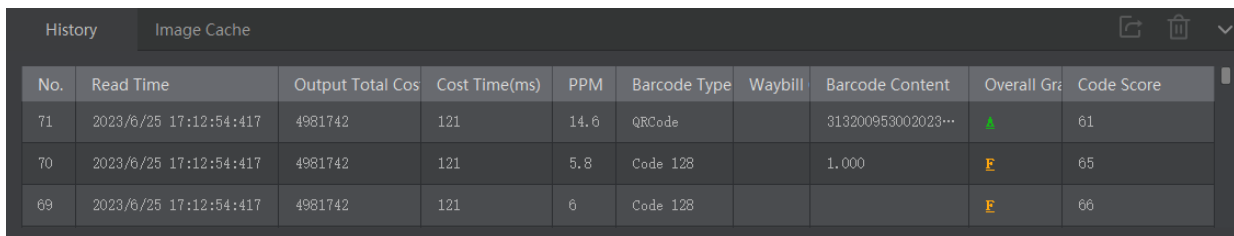

No.	Read Time	Output Total Cos	Cost Time(ms)	PPM	Barcode Type	Waybill	Barcode Content	Overall Gr	Code Score
71	2023/6/25 17:12:54:417	4981742	121	14.6	QRCode		313200953002023...	▲	61
70	2023/6/25 17:12:54:417	4981742	121	5.8	Code 128		1.000	E	65
69	2023/6/25 17:12:54:417	4981742	121	6	Code 128			E	66

Figure 9-24 Overall Code Quality

Set 2D Code Quality Evaluation

The 2D quality evaluation function uses the ISO15415 standard to judges the quality of codes and outputs overall grade.

 **Note**

- The specific parameters may differ by device models and firmware versions.
- Make sure that the device's operation mode is normal and 2D codes added.

Steps

1. Go to **Algorithm Control** → **Algorithm Parameter**, and select **2D Code** as **Arithmetic Type**.
2. Enable **2D Code Quality Evaluation**.
3. Set **Iso Edition**, including **Iso15415** and **Iso29158**
 - Iso15415 is applicable to the quality evaluation for label 2-dimensional codes.
 - Iso29158 is applicable to the quality evaluation for DPM format 2-dimensional codes.
4. Refer to step 5 to step 7 in **Set 1D Code Quality Evaluation** to set other parameters.

9.3.5 Set Code Score

The code score function evaluates the code-reading environment for codes and outputs code score.

Note

- The function of code score may differ by device models.
 - In test mode, this function is enabled by default. In normal mode, you need to enable it manually.
 - The code score is determined by two factors including image quality and print quality of codes. The range of code score is between 0 and 100, and the higher the score, and easier the code can be read.
-

Steps

1. Go to **Algorithm Settings**, and enable **Code Score Enable**.

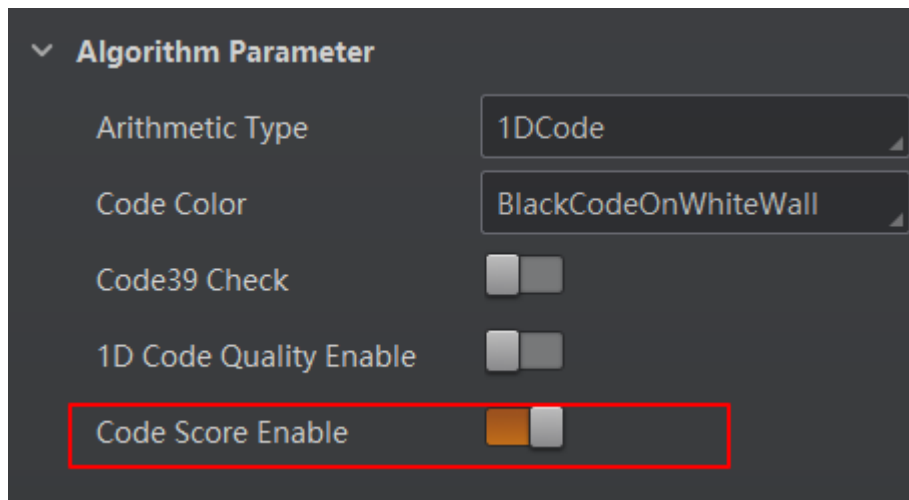

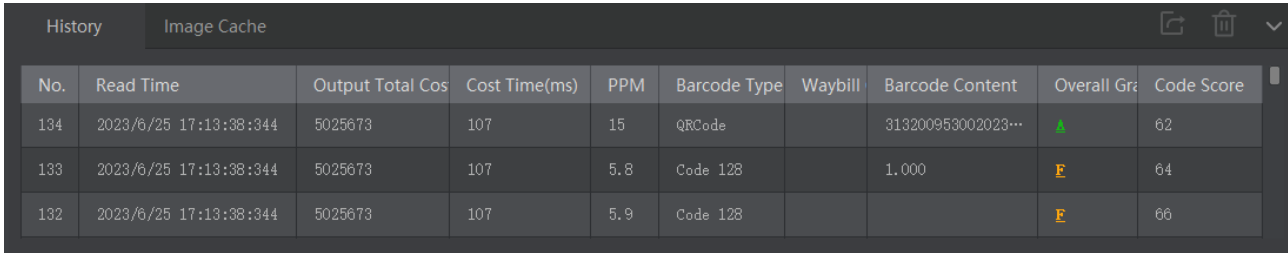

Figure 9-25 Enable Code Score Enable

2. Click  to start acquisition, and the client software will display specific code score in the history record area.





No.	Read Time	Output Total Cos	Cost Time(ms)	PPM	Barcode Type	Waybill	Barcode Content	Overall Gr	Code Score
134	2023/6/25 17:13:38:344	5025673	107	15	QRCode		313200953002023...		62
133	2023/6/25 17:13:38:344	5025673	107	5.8	Code 128		1.000		64
132	2023/6/25 17:13:38:344	5025673	107	5.9	Code 128				66

Figure 9-26 Code Score

3. (Optional) Go to **Image Settings**, and adjust parameters like exposure time, gain, Gamma, light source, etc. if the code score is low.

Note

If the code score is still low after adjusting, and the code may have poor printing quality.

9.4 Signal Input Settings

The input settings allow you to configure the trigger related parameters. You can enable trigger mode to let the acquisition of image data occur only when the trigger source is generated.

9.4.1 Set Trigger Mode

The device has 2 types of trigger mode: Internal trigger mode and external trigger mode.

- **Internal Trigger Mode:** The device acquires images via its internal signals.
- **External Trigger Mode:** The device acquires images via external signals like software signal and hardware signal. The trigger source of external trigger mode includes software, physical lines, counter, TCP, UDP, etc.

9.4.2 Enable Internal Trigger Mode

In internal trigger mode, the device acquires images via its internal signals. You have 2 methods to enable the internal trigger mode:

- Click **I/O Control Settings** → **Input** → **Trigger Mode**, and select **Off** as **Trigger Mode**.
- In the live view page, click  to enable the internal trigger mode.

9.4.3 Enable External Trigger Mode

In external trigger mode, the device acquires images via external signals like software signal

and hardware signal. You have 2 methods to enable the external trigger mode:

- Click **I/O Control Settings** → **Input** → **Trigger Mode**, and select **On** as **Trigger Mode**.
- In the live view page, click  to enable the external trigger mode.

Set and Execute Software Trigger Mode

In software trigger, the software sends trigger signal to the device to acquire images.

Steps

1. Go to **I/O Control Settings** → **Input** → **Trigger Mode**.
2. Select **On** as **Trigger Mode**.
3. Select **Software** as **Trigger Source**.
4. Click **Execute** in **Trigger Source** to send trigger commands.
5. (Optional) Enter **Auto Trigger Time**, and enable **Enable Auto Trigger** to let the client software automatically send trigger signal to device according to the interval you set.

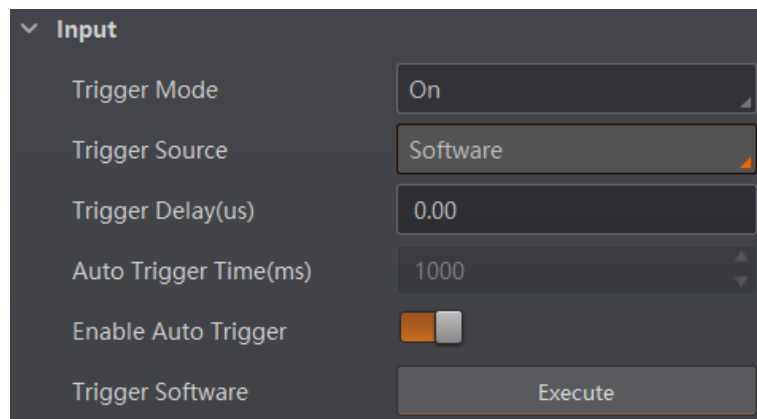

Figure 9-27 Set and Execute Software Trigger Mode

Set and Execute Hardware Trigger Mode

Steps

1. Go to **I/O Control Settings** → **Input** → **Trigger Mode**.
2. Select **On** as **Trigger Mode**.
3. Select the specific line as **Trigger Source** according to actual demands.
4. Set **Debounce Time** and **Trigger Activation** according to actual demands.

Note

- When selecting **Rising Edge** or **Falling Edge** as **Trigger Activation**, you can set **Trigger Delay**.
 - When selecting **Level High** or **Level Low** as **Trigger Activation**, you can set **Start Delay Time** and **End Delay Time** according to actual demands.
-

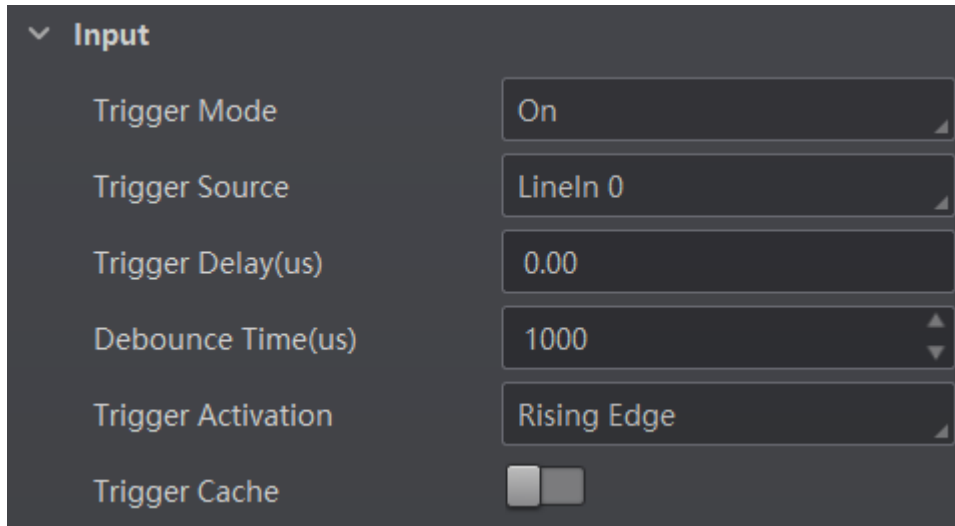

Figure 9-28 Set and Execute Hardware Trigger Mode

Set and Execute Counter Trigger Mode

Counter specifies that the trigger source will be generated after the set number of valid signals appears. For example, if you set the **Count Number** to **3**, the trigger source will be generated after 3 signals appear.

Steps

1. Go to **I/O Control Settings** → **Input** → **Trigger Mode**.
2. Select **On** as **Trigger Mode**.
3. Select **Counter 0** as **Trigger Source**.
4. Set **Trigger Delay**, **Count Number**, **Count Source**, and **Trigger Activation**

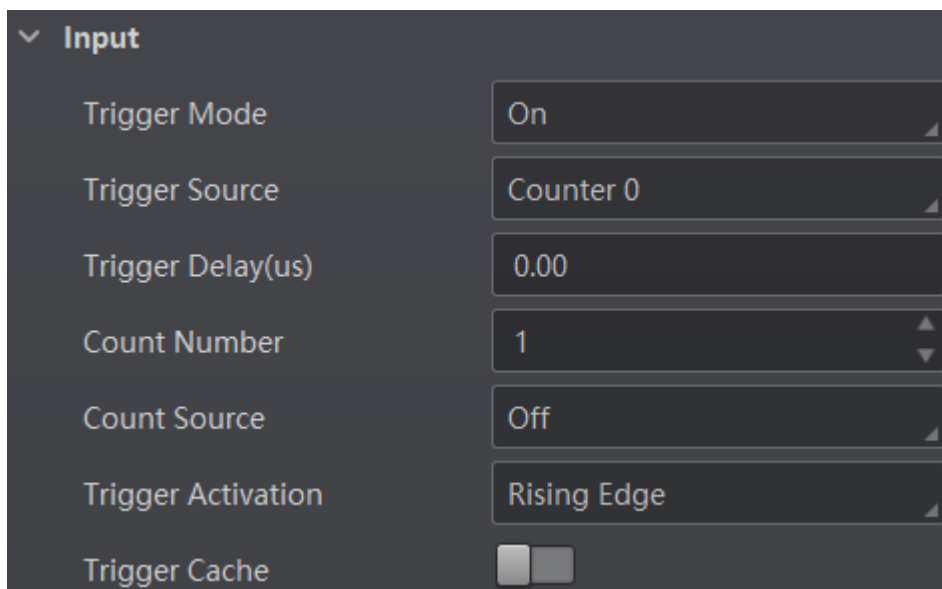

Figure 9-29 Set and Execute Counter Trigger Mode

Set and Execute TCP Trigger Mode

TCP start specifies the TCP server as the source for the trigger signal. When the server receives the specified string text, the trigger signal will be outputted.

Steps

1. Go to **I/O Control Settings** → **Input** → **Trigger Mode**.
2. Select **On** as **Trigger Mode**.
3. Select **TCP Start** as **Trigger Source**.
4. Set following parameters according to actual demands.
 - **TCP Trigger Port**: It sets the host port of TCP trigger.
 - **TCP Start Trigger Text**: It sets the trigger text of TCP start, and it is **Start** by default.

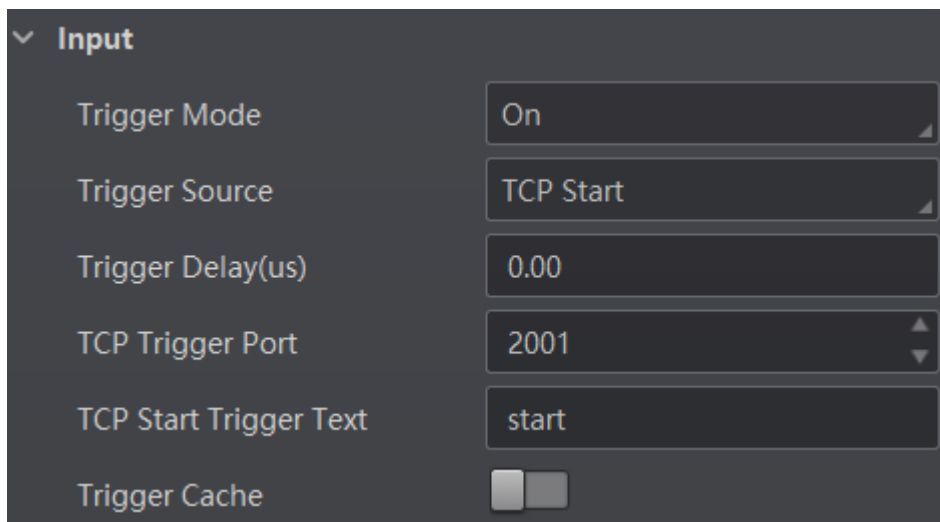

Figure 9-30 Set and Execute TCP Trigger Mode

Set and Execute UDP Trigger Mode

UDP start specifies the UDP server as the source for the trigger signal. When the server receives the specified string text, the trigger signal will be outputted.

Steps

1. Go to **I/O Control Settings** → **Input** → **Trigger Mode**.
2. Select **On** as **Trigger Mode**.
3. Select **UDP Start** as **Trigger Source**.
4. Set following parameters according to actual demands.
 - **UDP Trigger Port**: It sets the host port of UDP trigger.
 - **UDP Start Trigger Text**: It sets the trigger text of UDP start, and it is **Start** by default.

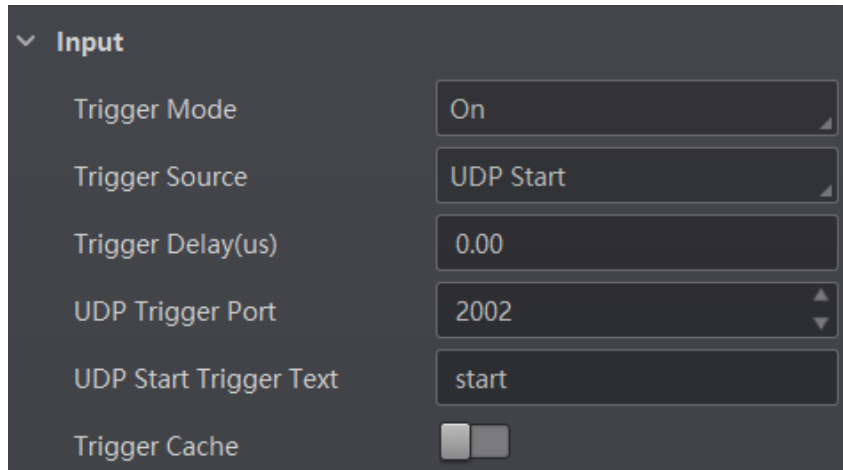

Figure 9-31 Set and Execute UDP Trigger Mode

Set and Execute Serial Port Trigger Mode

Serial start specifies the serial port as the source for the trigger signal. When the serial port receives the specified string text, the trigger signal will be outputted.

Steps

1. Go to **I/O Control Settings** → **Input** → **Trigger Mode**.
2. Select **On** as **Trigger Mode**.
3. Select **Serial Start** as **Trigger Source**.
4. **Serial Baudrate**, **Serial Data Bits**, **Serial Parity**, and **Serial Stop Bits**.
5. Set **Serial Start Trigger Text** that configures the trigger text of serial port start, and it is **Start** by default.

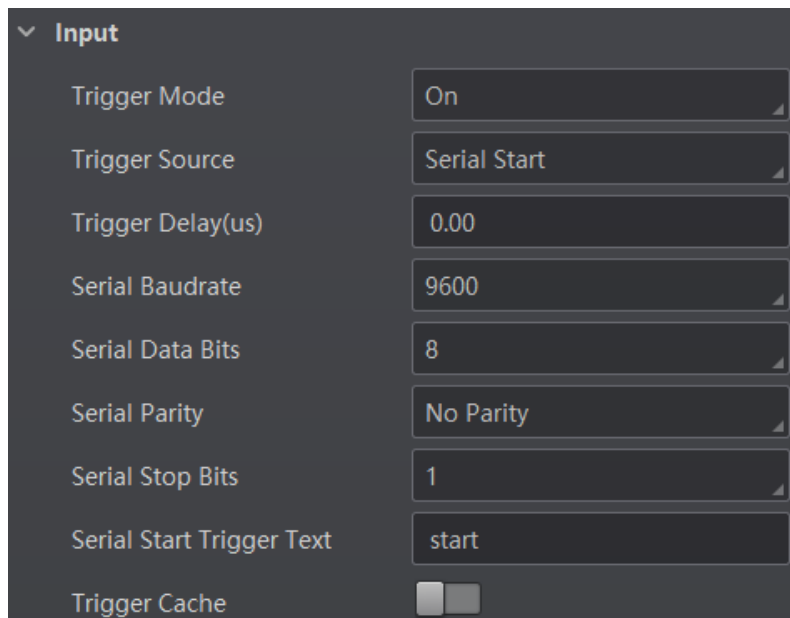

Figure 9-32 Set and Execute Serial Port Trigger Mode

Set and Execute Self Trigger Mode

Self trigger allows you to trigger the device according to the trigger period you configured.

Steps

1. Click **I/O Control Settings** → **Input** → **Trigger Mode**.
2. Select **On** as **Trigger Mode**.
3. Select **Self Trigger** as **Trigger Source**, set **Self Trigger Period** and **Self Trigger Count**.

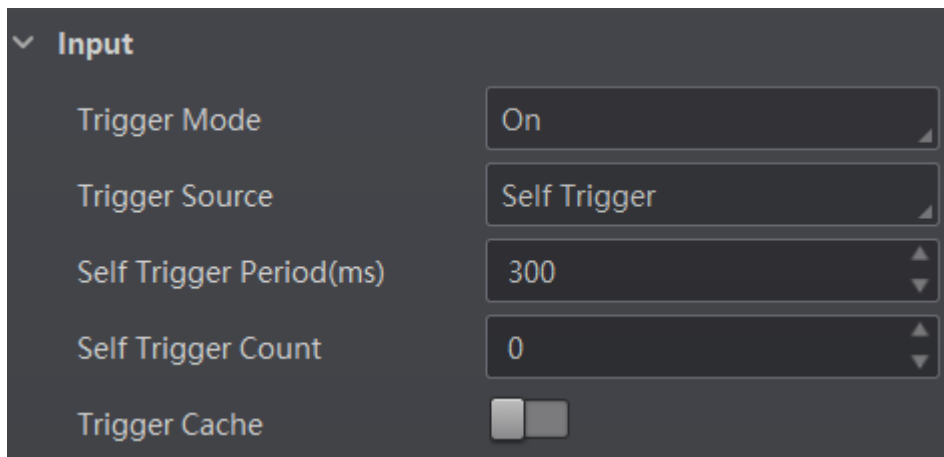

Figure 9-33 Set and Execute Self Trigger Mode

Note

- If the self-trigger count is set to 0, and it means that it can be triggered indefinitely until the execution of self-trigger stops.
- The self-trigger time shall be set to be greater than the reciprocal of the actual frame rate.

Set and Execute Brightness Tigger

When the brightness of the field of view changes, the code reader is triggered to acquire images and output code information automatically. The code reader monitors the change of image brightness value in real time and starts code reading when the change exceeds the configured sensitivity threshold.

Steps

1. Click **I/O Control Settings** → **Input** → **Trigger Mode**.
2. Select **On** as **Trigger Mode**.
3. Select **Brightness** as **Trigger Source**.
4. Set **Brightness Sensitivity** according to the actual demands.

9.4.4 Stop Trigger

The device supports stopping trigger via TCP, UDP, IO, and serial port. You can also set code

reading timeout duration or max. code amount to be read to stop trigger.

Stop Trigger via TCP

When the TCP server receives the specified string text, the trigger will be stopped.

Steps

1. Go to **I/O Control Settings** → **Stop Trigger**.
2. Enable **TCP Stop Trigger Enable**.
3. Set following parameters according to actual demands.
 - **TCP Trigger Port**: It is 2001 by default.
 - **TCP Stop Trigger Text**: It sets the stop trigger text, and it is **Stop** by default.

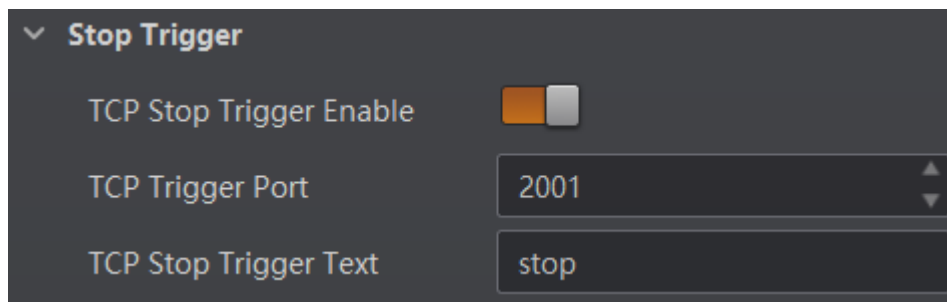

Figure 9-34 Stop Trigger via TCP

Stop Trigger via UDP

When the UDP receives the specified string text, the trigger will be stopped.

Steps

1. Go to **I/O Control Settings** → **Stop Trigger**.
2. Enable **UDP Stop Trigger Enable**.
3. Set following parameters according to actual demands.
 - **UDP Trigger Port**: It is 2002 by default.
 - **UDP Stop Trigger Text**: It sets the stop trigger text, and it is **Stop** by default.

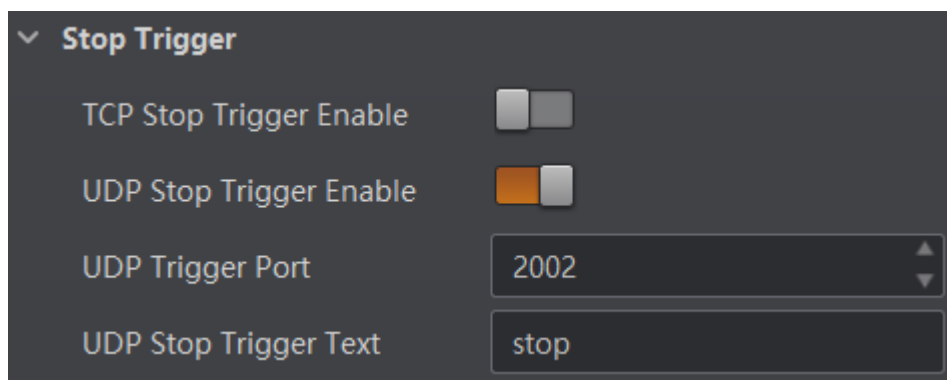

Figure 9-35 Stop Trigger via UDP

Stop Trigger via IO

Stopping trigger via IO allows you to select hardware or software trigger source to stop the device from acquiring images.

Steps

1. Go to **I/O Control Settings** → **Stop Trigger**.
2. Enable **IO Stop Trigger Enable**.
3. Select sources from **LineIn 0/1/2** and **Software Trigger End** as **IO Stop Trigger Selector**.
4. (Optional) Set trigger activation if **LineIn 0/1/2** is selected as **IO Stop Trigger Selector**.
5. (Optional) Click **Execute** in **Software Stop Trigger** to stop trigger if **Software Trigger End** is selected as **IO Stop Trigger Selector**.

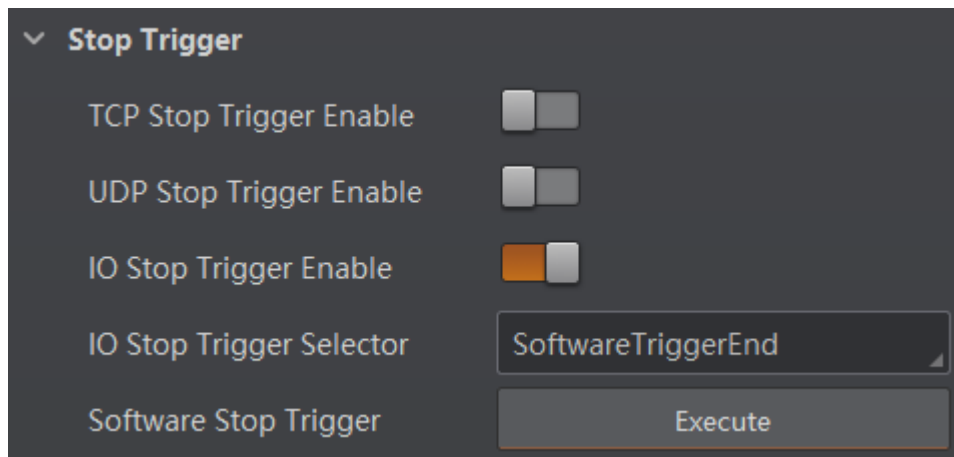

Figure 9-36 Stop Trigger via IO

Stop Trigger via Serial Port

When the specified serial port receives the specified string text, the trigger will be stopped.

Steps

1. Go to **I/O Control Settings** → **Stop Trigger**.
2. Enable **Serial Stop Trigger Enable**.
3. Set following parameters according to actual demands.
 - **Serial Stop Trigger Text:** It sets the trigger text of serial port stop, and it is **Stop** by default.
 - **Serial Baud Rate:** It sets the baud rate of the serial port, and it is 9600 by default.
 - **Serial Data Bits:** It sets the data bits of the serial port, and it is 8 by default.
 - **Serial Parity:** It sets the parity of the serial port, and it is **No Parity** by default.
 - **Serial Stop Bits:** It sets the stop bits of the serial port, and it is 1 by default.

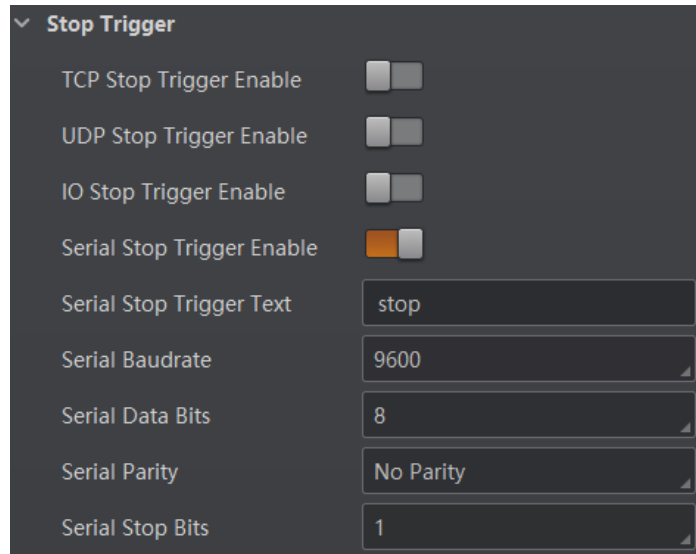

Figure 9-37 Stop Trigger via Serial Port

Stop Trigger via Timeout Duration

When the trigger time reaches the specified maximum value (ms), the trigger will be stopped. You can enable **TimeOut Stop Trigger Enable**, and set **Maximum Output Limited Time** according to actual demands.

Note

The range of **Maximum Output Limited Time** is between 0 ms and 10000 ms.

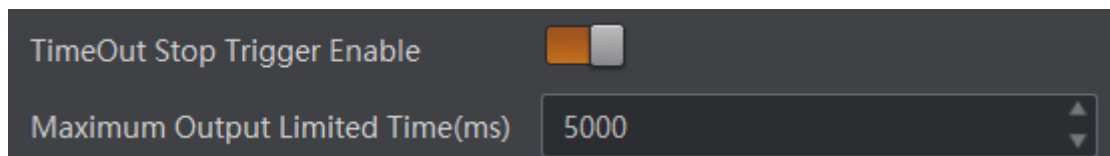

Figure 9-38 Stop Trigger via Timeout Duration

Stop Trigger via Code Number

This function means that the code quantity outputted by the device is restricted to the settings you configured here.

You can enable **CodeNum Stop Trigger Enable**, and set **CodeNum Stop Trigger Min** and **CodeNum Stop Trigger Max** according to actual demands.

Note

- If the outputted code quantity is smaller than configured **CodeNum Stop Trigger Min**, and the device will output codes continuously.
- If the outputted code quantity is smaller than configured **CodeNum Stop Trigger Max**, and the device will stop outputting codes.

- If the outputted code quantity is between configured **CodeNum Stop Trigger Min** and **CodeNum Stop Trigger Max**, and the device will read and output codes according to trigger signals.
 - If **CodeNum Stop Trigger Min** is same with **CodeNum Stop Trigger Max**, and the device will stop outputting codes when the number of outputted codes reaches the configured number.
-

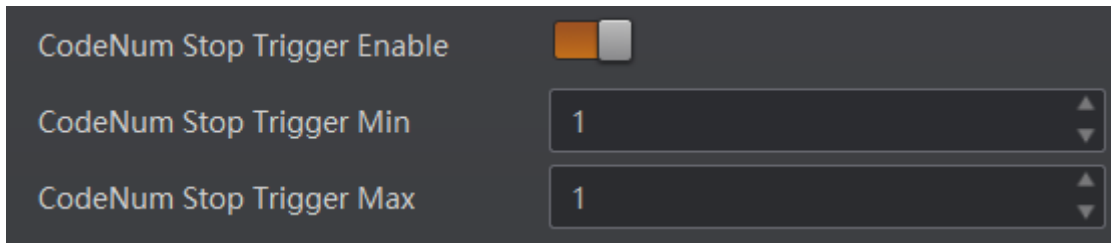

Figure 9-39 Stop Trigger via Code Number

9.5 Signal Output Settings

9.5.1 Select Output Signal

The device's output signal can control external devices like PLC, flashing light, etc. Click **I/O Control Settings** → **Output** → **Line Out Selector** to select output signals.

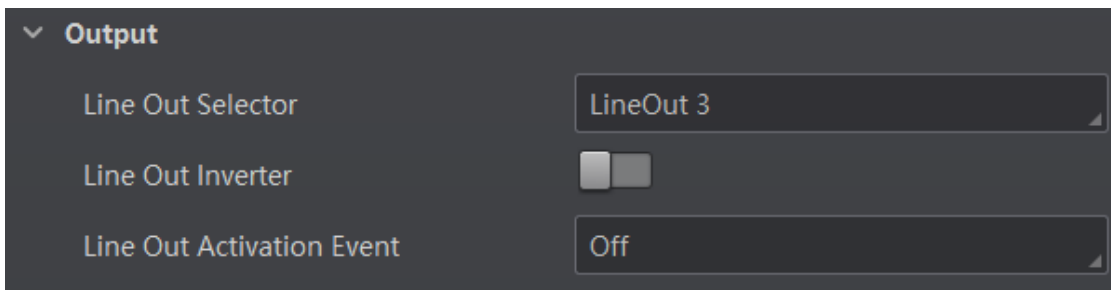

Figure 9-40 Select Output Signal

9.5.2 Set Event Source

Note

The specific event sources may differ by device models and firmware versions.

The device supports outputting different trigger signals according to the event source you select. Click **I/O Control Settings** → **Output** → **Line Out Activation Event** to select event source.

The device supports following event sources: **Off**, **Acquisition Start Active**, **Acquisition Stop**

Active, Frame Burst Start Active, Frame Burst Stop Active, Exposure Start Active, Soft Trigger Active, Hard Trigger Active, Counter Active, Timer Active, No Code Read, Read Success, Light Strobe Long, Contrast Success, Contrast Fai, and Command Control IO.

 **Note**

- **Off** refers to no event source.
 - You need to set different parameters when selecting various event sources.
-

Select Acquisition Start Active

If you select **Acquisition Start Active** as **Line Out Activation Event**, and you can set its output delay time and duration.

- **Line Out Delay Time:** It sets the delay time for outputting the output signal.
- **Line Out Duration:** It sets the time duration of the output signal.

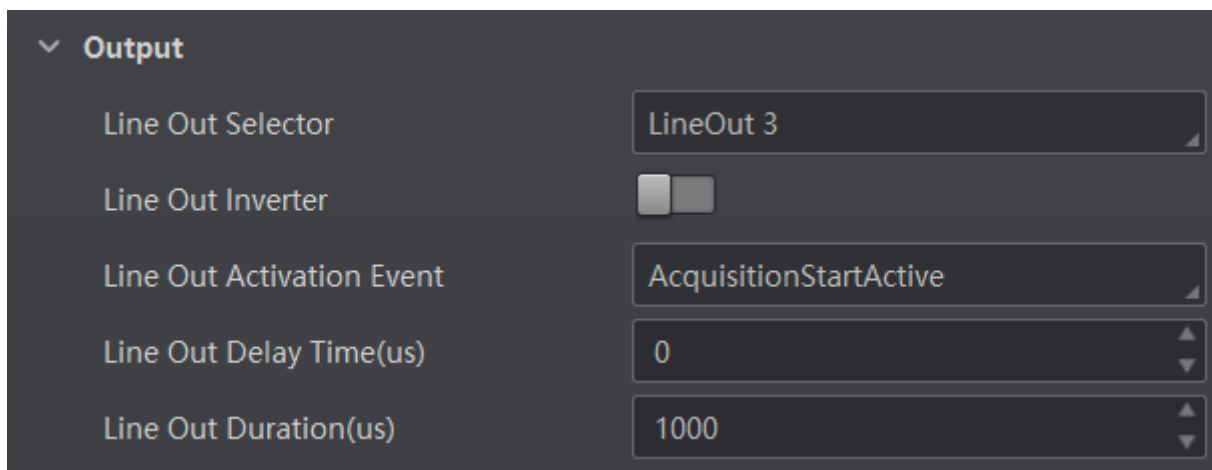

Figure 9-41 Select Acquisition Start Active

Select Acquisition Stop Active

If you select **Acquisition Stop Active** as **Line Out Activation Event**, and you can set its output delay time and duration.

- **Line Out Delay Time:** It sets the delay time for outputting the output signal.
- **Line Out Duration:** It sets the time duration of the output signal.

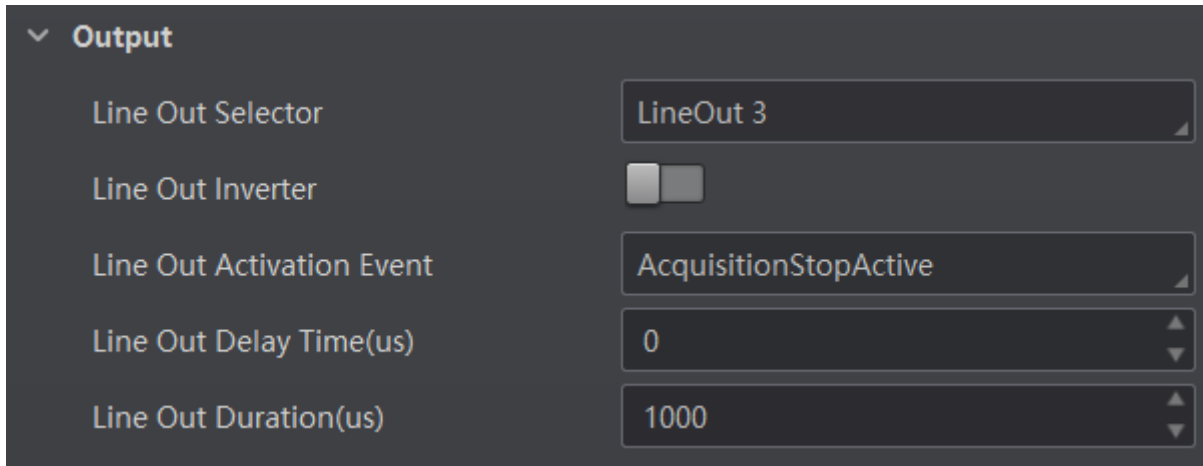

Figure 9-42 Select Acquisition Stop Active

Select Frame Burst Start Active

If you select **Frame Burst Start Active** as **Line Out Activation Event**, and you can set its output delay time and duration.

- **Line Out Delay Time:** It sets the delay time for outputting the output signal.
- **Line Out Duration:** It sets the time duration of the output signal.

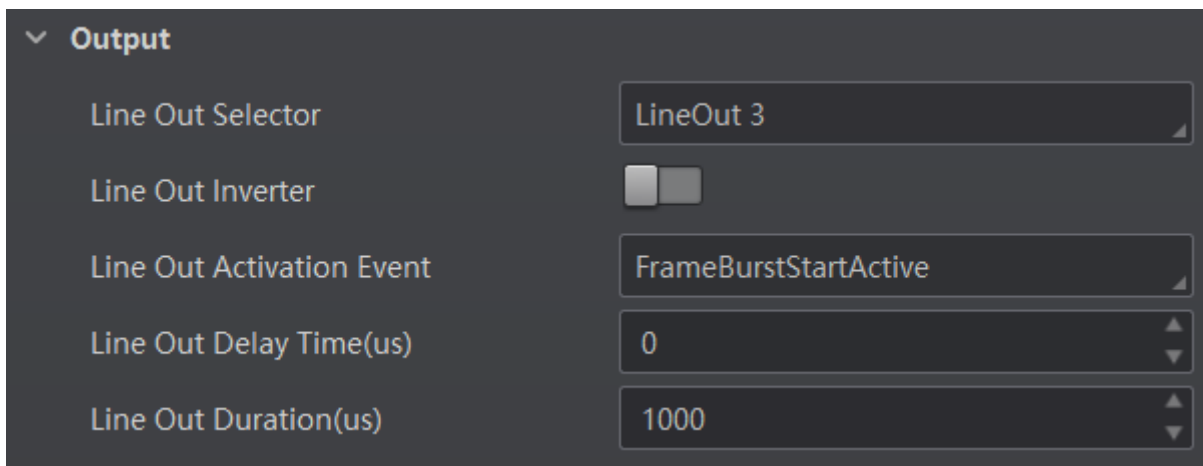

Figure 9-43 Select Frame Burst Start Active

Select Frame Burst Stop Active

If you select **Frame Burst Stop Active** as **Line Out Activation Event**, and you can set its output delay time and duration.

- **Line Out Delay Time:** It sets the delay time for outputting the output signal.
- **Line Out Duration:** It sets the time duration of the output signal.

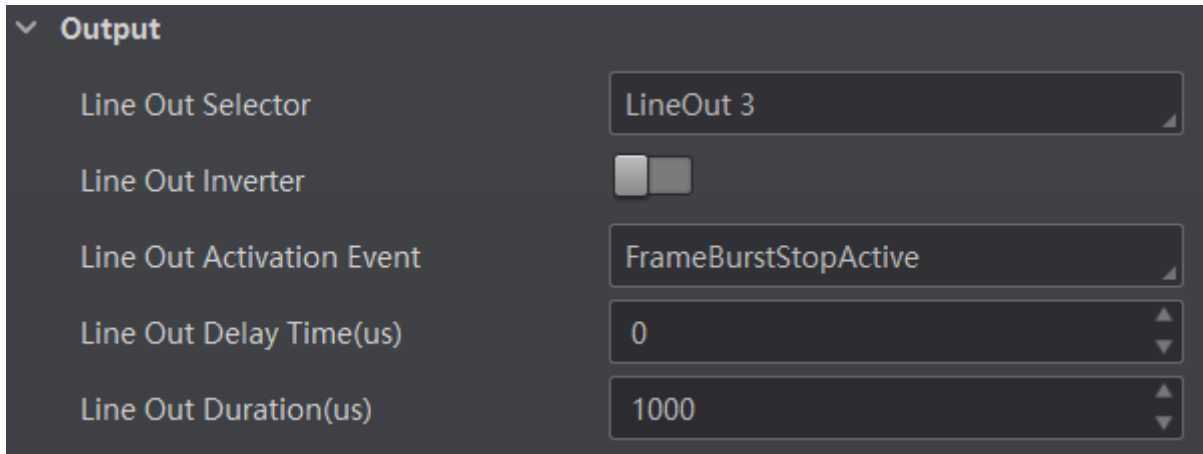

Figure 9-44 Select Frame Burst Stop Active

Select Exposure Start Active

If you select **Exposure Start Active** as **Line Out Activation Event**, and you can set its output delay time, duration and advance time.

- **Line Out Delay Time:** It sets the delay time for outputting the output signal.
- **Line Out Duration:** It sets the time duration of the output signal.
- **Line Out Ahead Time:** It sets the advance time of outputting the output signal.

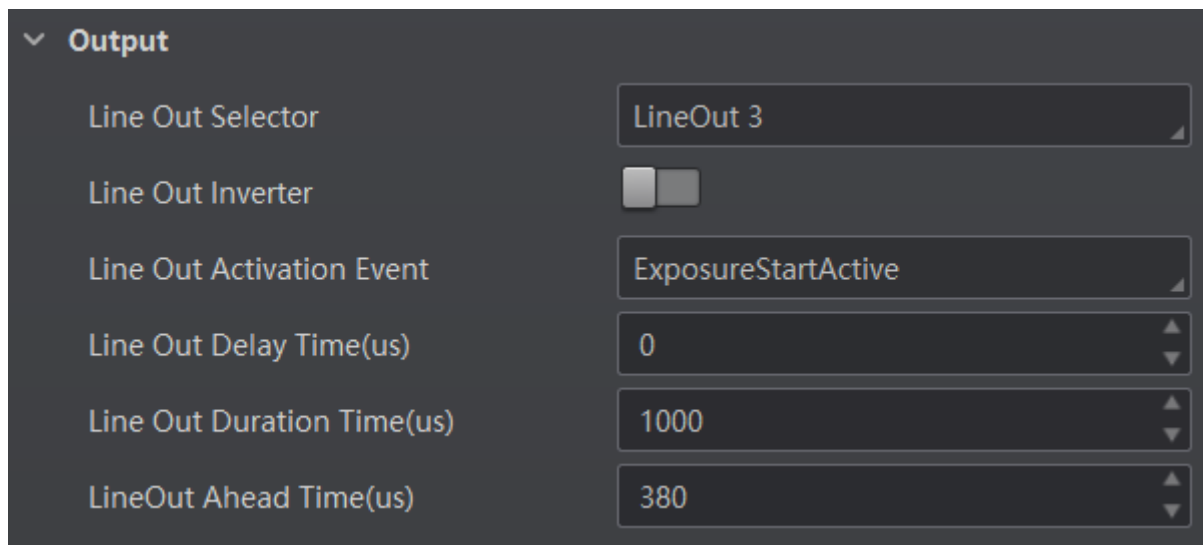

Figure 9-45 Select Exposure Start Active

Select Soft Trigger Active

If you select **Soft Trigger Active** as **Line Out Activation Event**, and you can set its output delay time, duration, and execute outputting signal manually.

- **Line Trigger Software:** Click **Execute** in **Line Trigger Software** to output the signal manually.

- **Line Out Delay Time:** It sets the delay time for outputting the output signal.
- **Line Out Duration:** It sets the time duration of the output signal.

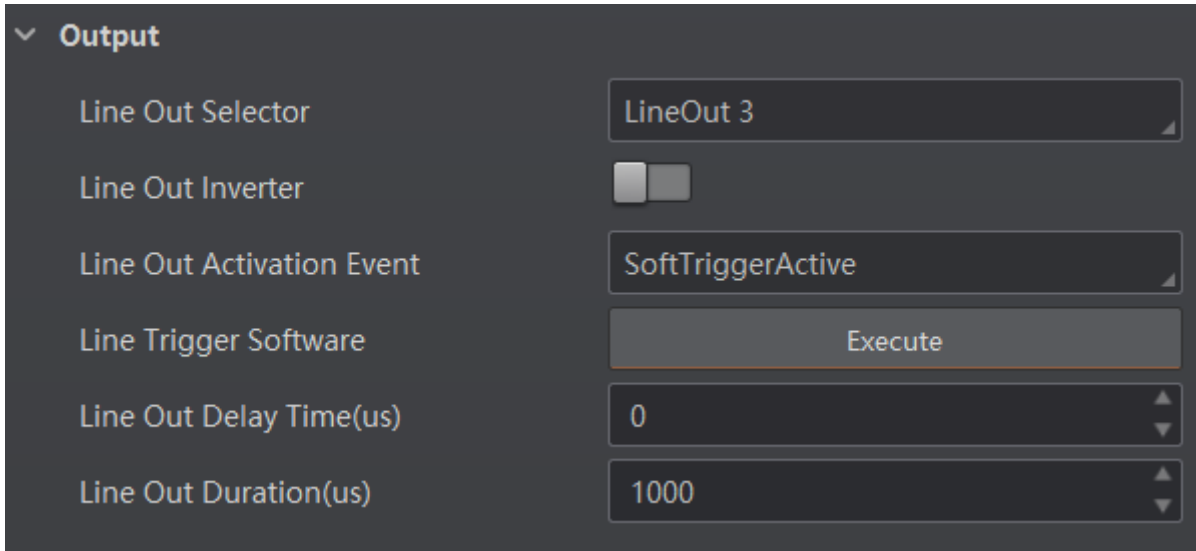

Figure 9-46 Select Soft Trigger Active

Select Hard Trigger Active

If you select **Hard Trigger Active** as **Line Out Activation Event**, and you can set its output delay time, duration, trigger source, and trigger activation.

- **Hardware Trigger Source:** It sets the hardware trigger source.
- **Hardware Trigger Activation:** It sets the trigger activation of input signal, including **Rising Edge** and **Falling Edge**.
- **Line Out Delay Time:** It sets the delay time for outputting the output signal.
- **Line Out Duration:** It sets the time duration of the output signal.

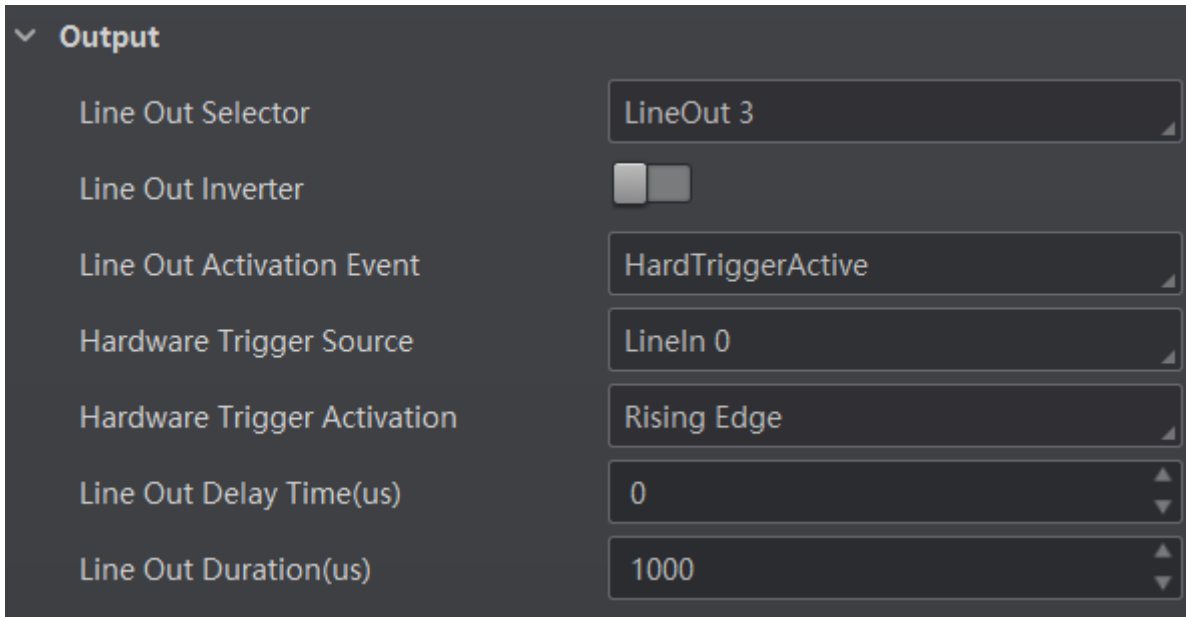

Figure 9-47 Select Hard Trigger Active

Select Counter Active

If you select **Counter Active** as **Line Out Activation Event**, and you can set its output delay time and duration.

- **Line Out Delay Time:** It sets the delay time for outputting the output signal.
- **Line Out Duration:** It sets the time duration of the output signal.

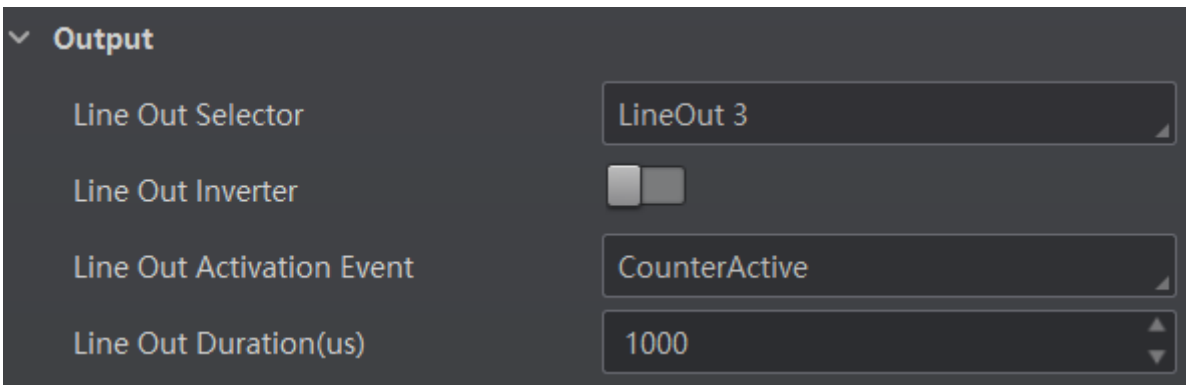

Figure 9-48 Select Counter Active

Select Timer Active

If you select **Timer Active** as **Line Out Activation Event**, and you can set its output duration and period.

- **Line Out Duration:** It sets the time duration of the output signal.
- **Line Out Period:** It sets the time period of the output signal.

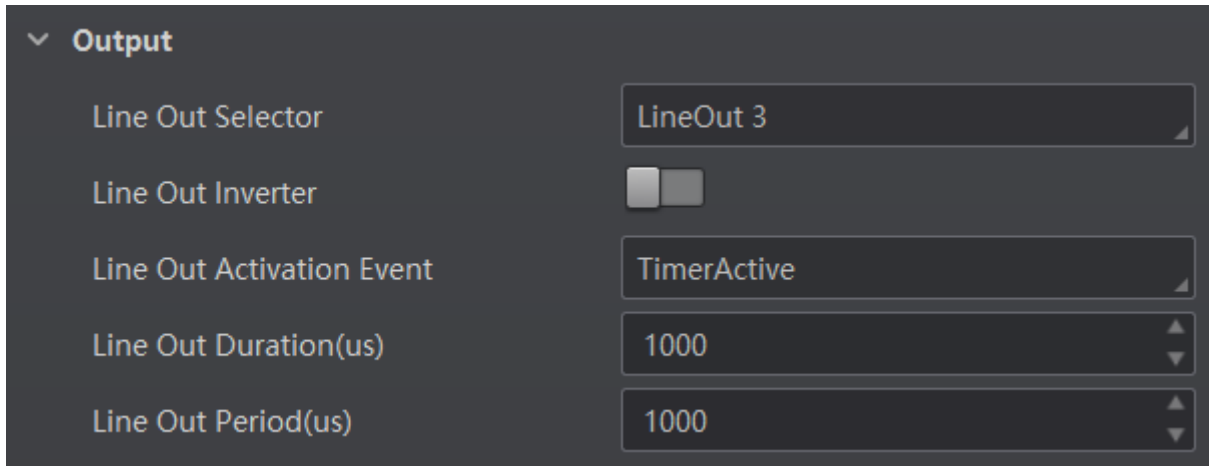

Figure 9-49 Select Timer Active

Select No Code Read

If you select **No Code Read** as **Line Out Activation Event**, and you can set its output delay time and duration.

- **Line Out Delay Time:** It sets the delay time for outputting the output signal.
- **Line Out Duration:** It sets the time duration of the output signal.

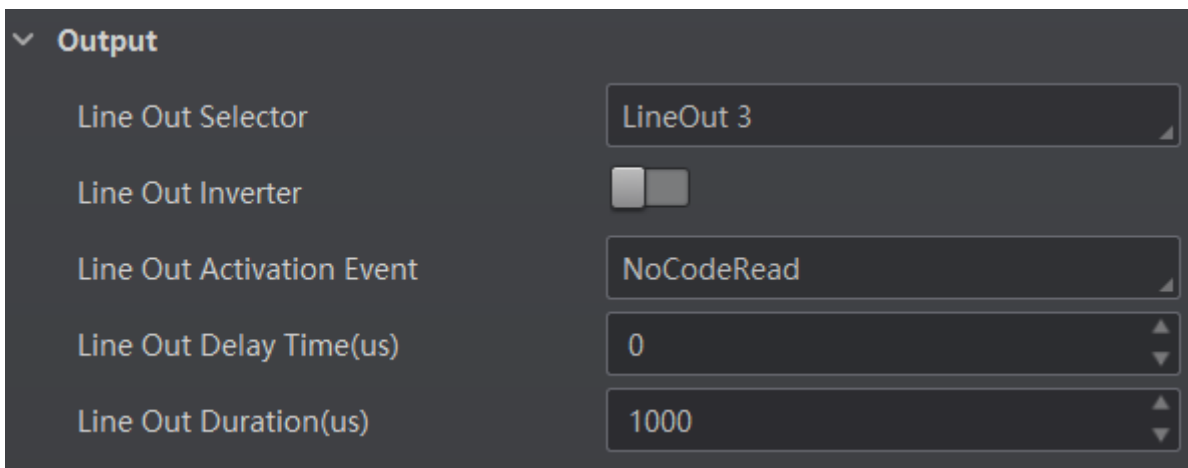

Figure 9-50 Select No Code Read

Select Read Success

If you select **Read Success** as **Line Out Activation Event**, and you can set its output delay time and duration.

- **Line Out Delay Time:** It sets the delay time for outputting the output signal.
- **Line Out Duration:** It sets the time duration of the output signal.

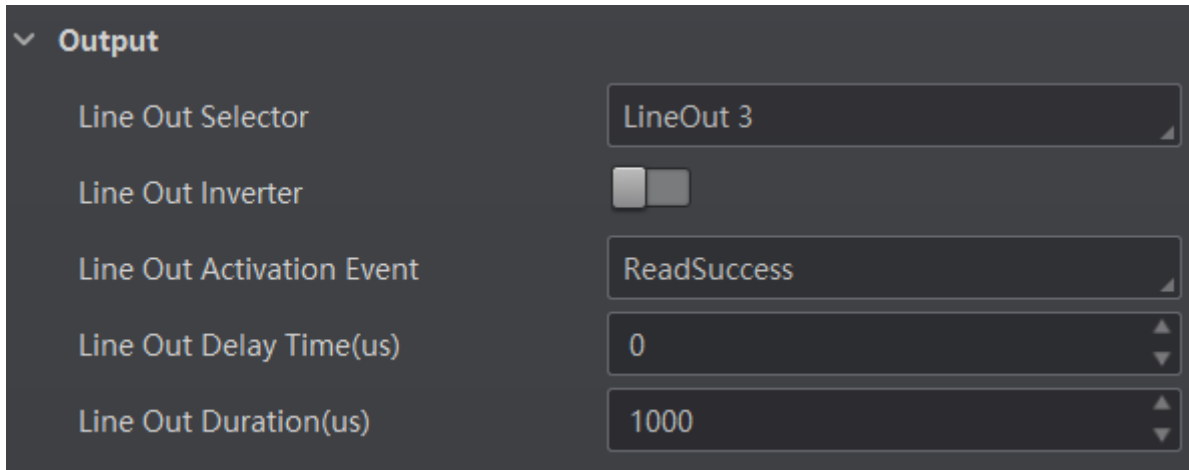

Figure 9-51 Select Read Success

Select Compare Success

If you select **Compare Success** as **Line Out Activation Event**, and you can set its output delay time and duration.

- **Line Out Delay Time:** It sets the delay time for outputting the output signal.
- **Line Out Duration:** It sets the time duration of the output signal.

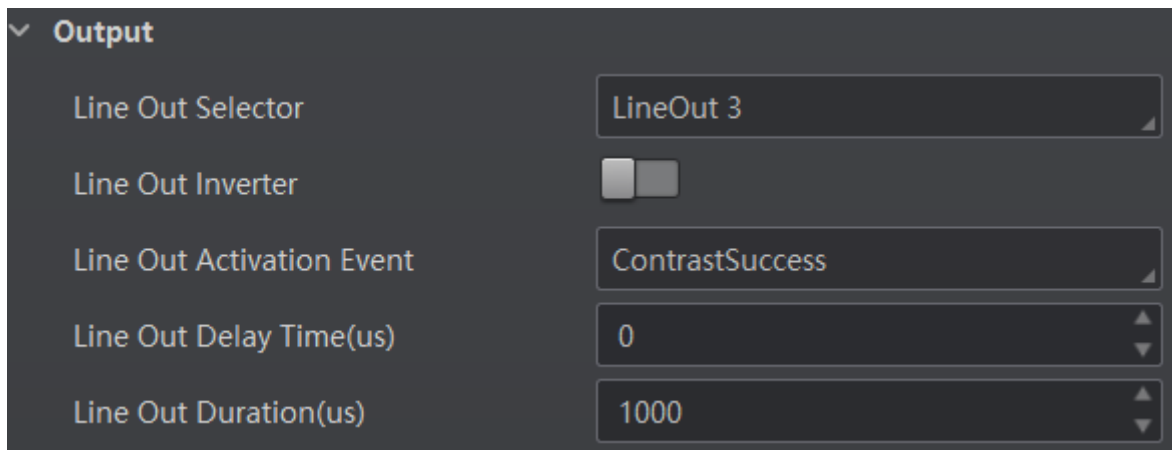

Figure 9-52 Select Compare Success

Select Compare Fail

If you select **Compare Fail** as **Line Out Activation Event**, and you can set its output delay time and duration.

- **Line Out Delay Time:** It sets the delay time for outputting the output signal.
- **Line Out Duration:** It sets the time duration of the output signal.

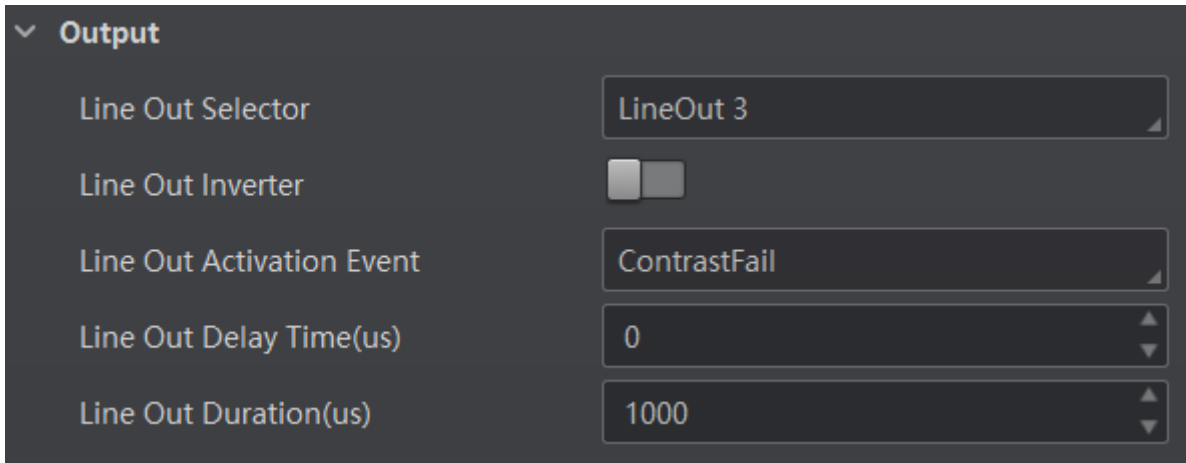

Figure 9-53 Select Compare Fail

Select Light Strobe Long

If you select **Light Strobe Long** as **Line Out Activation Event**, and you do not need to set any parameters.

Select Command Control IO

If you select **Command Control IO** as **Line Out Activation Event**, and you do not need to set any parameters.

- **Control Start Str:** It sets the start string of command control.
- **Control Stop Str:** It sets the stop string of command control.
- **Line Out Delay Time:** It sets the delay time for outputting the output signal.
- **Line Out Duration:** It sets the time duration of the output signal.

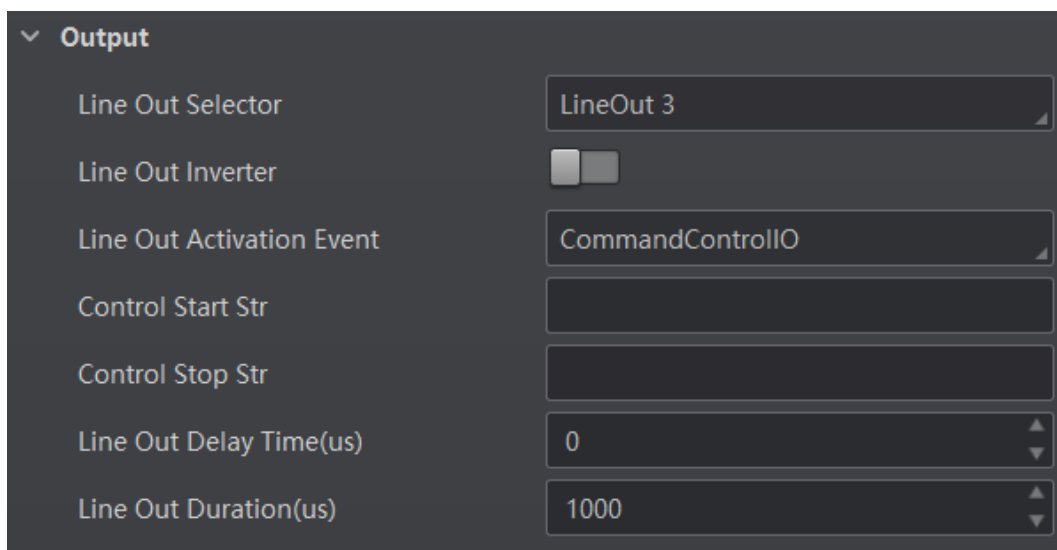

Figure 9-54 Select Command Control IO

9.5.3 Enable Line Inverter

The line inverter function allows the device to invert the electrical signal level of an I/O signal, and meet requirements of different devices for high or low electrical signal level. You can go to **I/O Control Settings** → **Output**, and enable **Line Out Inverter**.

Note

The **Line Out Inverter** function is disabled by default.

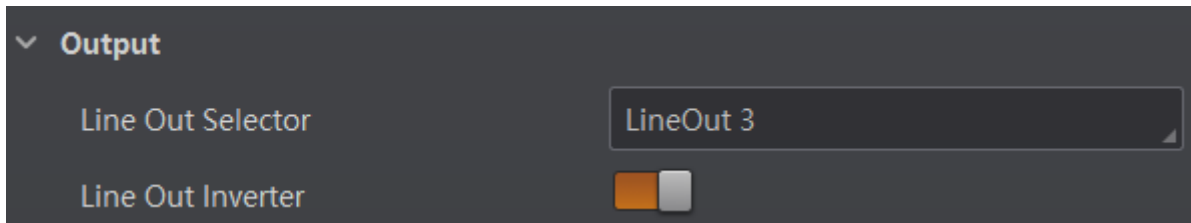

Figure 9-55 Enable Line Out Inverter

9.6 Communication Settings

The communication protocol is used to transmit and output code reading result and image. The communication protocol is related to the device modes. With various device modes, the device supports different communication protocols and corresponding parameters.

- If the device's operation mode is **Test** or **Raw**, and it only supports **SmartSDK** protocol and no parameter settings are required.
- If the device's operation mode is **Normal**, and it supports **SmartSDK**, **TCP Client**, **Serial**, **FTP**, **TCP Server**, **Profinet**, **MELSEC**, **Ethernet/IP**, **ModBus**, **UDP**, and **Fins** communication protocols, and you need to set corresponding parameters.

Note

- The supported communication protocols may differ by device models.
- The specific parameters of communication protocols may differ by device models.

9.6.1 Set SmartSDK

If you select **SmartSDK** as the communication protocol, you can configure the following parameters:

Table 9-8 SmartSDK Communication Protocol

Parameter	Description
SmartSDK Protocol	If enabled, the device will output data via SmartSDK.
Encode JPEG Flag	The device will compress images in JPG format after enabling it.

Parameter	Description
Quantity of JPG	It sets the image compression quality, and it ranges from 50 to 99.

9.6.2 Set TCP Client

If you select **TCP Client** as the communication protocol, you can configure the following parameters:

Table 9-9 TCP Client Communication Protocol

Parameter	Description
TCP Protocol	If enabled, the device will output data via the TCP server.
TCP Dst Addr	Enter the IP address of the server that receives data outputted by the code reader.
TCP Dst Port	Enter the port No. of the server that receives data outputted by the code reader.
Heartbeat Enable	If enabled, the software will send heartbeat text.
Barcode as Heartbeat	If enabled, you can set heartbeat text and time.
Heartbeat Text	Enter the content of heartbeat text.
Heartbeat Time	Set the duration of the heartbeat.

9.6.3 Set Serial

If you select **Serial** as the communication protocol, you can configure the following parameters:

Table 9-10 Serial Communication Protocol

Parameter	Description
Serial Protocol	If enabled, the code reader will output data via serial port.
Serial Baudrate	The baud rate of the serial port of the PC that receives data.
Serial Data Bits	Data bits of the serial port of the PC that receives data.  Note The hexadecimal trigger is supported only when Serial Data Bits is 8.
Serial Parity	Parity bits of the serial port of the PC that receives data.
Serial Stop Bits	Stop bits of the serial port of the PC that receives data.

9.6.4 Set FTP

If you select **FTP** as the communication protocol, you can configure the following parameters:

Table 9-11 FTP Communication Protocol

Parameter	Description
FTP Protocol	If enabled, the code reader will output data via FTP server.
FTP Host Addr	IP address of the FTP host.
FTP Host Port	Port No. of the FTP host.
FTP User Name	User name of the FTP.
FTP User PWD	Password of the FTP.

9.6.5 Set TCP Server

If you select **TCP Server** as the communication protocol, you can configure the following parameters:

Table 9-12 TCP Server Communication Protocol

Parameter	Description
TCP Server Enable	If enabled, the code reader will output data via TCP server.
TCP Server Port	The port No. of the TCP server that receives data outputted by code reader.

9.6.6 Set Profinet

If you select **Profinet** as the communication protocol, you can configure the following parameters:

Table 9-13 Profinet Communication Protocol

Parameter	Description
Profinet Enable	If enabled, the device will output data via Profinet protocol.
Profinet Device Name	Enter the name of the code reader, which is used for code reader recognition in Profinet protocol communication.
Profinet Result Module Size	Select from the drop-down list the result module size.
Profinet Result Timeout	Set the maximum waiting time for the result (unit: s).

9.6.7 Set MELSEC

If you select **Melsec/SLMP** as the communication protocol, you can configure the following parameters:

Table 9-14 MELSEC Communication Protocol

Parameter	Description
MELSEC Protocol Enable	If enabled, the code reader will output data via MELSEC protocol.
MELSEC Server IP	IP address of the Programmable Logic Controller (PLC) connected to the code reader.
MELSEC Server Port	Port number of the Programmable Logic Controller (PLC) connected to the code reader.
MELSEC Frame Type	Frame type of the MELSEC.
MELSEC Network Number	Network number to communicate with.
MELSEC Node Number	Node number to communicate with.
MELSEC Processer Number	Processor number to communicate with.
MELSEC Control Poll Interval	Requested time between successive polls of the control block from the PLC.
MELSEC Control Space	It sets storage space of the control area.
MELSEC Control Offset	It sets the start offset address of the control area.
MELSEC Control Size (Word)	It sets the size of the control area.
MELSEC Status Space	It sets storage space of the status area.
MELSEC Status Offset	It sets the start offset address of the status area.
MELSEC Status Size (Word)	It sets the size of the status area.
MELSEC Result Space	It sets storage space of the result area.
MELSEC Result Offset	It sets the start offset address of the result area.
MELSEC Result Size (World)	It sets the size of the result area.
MELSEC Result Byte Swap	If it is enabled, the client software will swap MELSEC results.
MELSEC Result Timeout	It sets the MELSEC result timeout, and the unit is s.

9.6.8 Set Ethernet/IP

If you select **EthernetIp** as the communication protocol, you can configure the following parameters:

Table 9-15 Ethernet/IP Communication Protocol

Parameter	Description
Ethernet/IP Enable	If enabled, the code reader will output data via Ethernet/IP protocol.
Ethernet/IP Input Assembly Size (Byte)	It sets input assembly size of the Ethernet/IP protocol.
Ethernet/IP Output Assembly Size (Byte)	It sets output assembly size of the Ethernet/IP protocol.
Ethernet/IP Result Byte Swap	If enabled, it will swap the results.
Ethernet/IP Result Timeout (s)	It sets the result timeout of the Ethernet/IP protocol.

9.6.9 Set ModBus

If you select **Modbus** as the communication protocol, you can configure the following parameters:

Table 9-16 ModBus Communication Protocol

ModBus	Description
ModBus Enable	If enabled, the code reader will output data via ModBus protocol.
ModBus Mode	Select a mode from Server and Client .
ModBus Control Space	The value is "holding_register" by default and not editable.
ModBus Control Offset	Offset of the control address. The default value is 0.
ModBus Control Size	The value is 1 by default.
ModBus Status Space	It sets status space and it is "holding_register" by default.
ModBus Status Offset	It sets status offset and it is 1 by default.
ModBus Status Size	It is 1 by default.
ModBus Result Space	It set result space and it is "holding_register" by default.
ModBus Result Offset	It is 2 by default.
ModBus Result Size	It is 100 by default.

ModBus	Description
ModBus Result Byte Swap	If it is enabled, the client software will swap ModBus results.
ModBus Result Timeout (s)	It sets the result timeout of the ModBus protocol.

9.6.10 UDP

If you select **UDP** as the communication protocol, you can configure the following parameters:

Table 9-17 UDP Communication Protocol

Parameter	Description
UDP Protocol Enable	If enabled, the code reader will output data via User Datagram Protocol (UDP).
UDP Dst IP	The IP address of the PC receiving the output data.
UDP Dst Port	The port of the PC receiving the output data.

9.6.11 Fins

If you select **Fins** as the communication protocol, you can configure the following parameters:

Table 9-18 Fins Communication Protocol

Parameter	Description
Fins Enable	If enabled, the code reader will output data via TCP/UDP FIN.
Fins Server IP	It sets the server IP of Fins.
Fins Server Port	It is 9600 by default.
Fins Control Poll Interval (ms)	It sets how often read data.
Fins Control Space	It sets storage space of the control area.
Fins Control Offset	It sets the start offset address of the control area.
Fins Control Size (Word)	It sets the size of the control area.
Fins Status Space	It sets storage space of the status area.
Fins Status Offset	It sets the start offset address of the status area.
Fins Status Size (Word)	It sets the size of the status area.

Parameter	Description
Fins Result Space	It sets storage space of the result area.
Fins Result Offset	It sets the start offset address of the result area.
Fins Result Size (Word)	It sets the size of the result area.
Fins Result Byte Swap	If it is enabled, the client software will swap Fins results.
Fins Result Timeout (s)	It sets the Fins result timeout, and the unit is s.

9.7 Data Processing Settings

In **Data Processing**, you can set filter rules for reading codes and other data processing related parameters.

Note

The specific parameters may differ by device models and firmware versions.

9.7.1 Set Filter Rule

You can set rules via **Filter Rule** to filter unwanted codes to improve the reading efficiency.

Normal Filter Mode

If the device's operation mode is normal, trigger mode is on, filter mode is normal, and you can set following parameters according to actual demands:

- **Instant Output Mode Enable:** If enabled, the device will output barcode data immediately once a code is read. If not enabled, the barcode data will be outputted after the device trigger process ends.

Note

The parameter is only available when the running mode is set to Normal mode and the trigger mode is enabled.

- **Min. Output Time(ms) :** Define the minimum time duration (unit: ms) for data output. The duration starts from trigger time. Note: The parameter is only available when the running mode is set to Normal mode and the trigger mode is enabled.

Note

The parameter is only available when the running mode is set to Normal mode and the trigger mode is enabled.

- **Min. Code Length:** If the length of a barcode is shorter (in terms of the number of

characters) than the configured value, the device will NOT parse the barcode.
For example, if you set the value to 6, the device will not parse the barcodes which contain fewer than 6 characters.

Note

The valid value of the parameter is from 1 to 256.

- **Max. Code Length:** If the length of a barcode is longer (in terms of the number of characters) than the configured value, the device will NOT parse the barcode.
For example, if you set the value to 9, the device will not parse the barcodes which contain more than 9 characters.

Note

The valid value of the parameter is from 1 to 256.

- **Numeral Filter:** If enabled, the device will only parse and read the numeral contents of the barcodes, and the non-numeral contents will be filtered out.
- **Begin with Specific Character for Result:** enabled, the device will only read the barcodes which begin with a specific character string.
- **Begins with:** Enter the character string.
- **Include Specific Character in Barcode:** If enabled, the device will only read the barcodes which include a specific character string.
- **Character:** Enter the character string.
- **Exclude Specific Character in Barcode:** If enabled, the device will only read the barcodes without a specific character string.
- **Character:** Enter the character string.
- **Remove Duplicate By ROI:** If it is enabled, the device will filter information based on drawn ROIs.
- **Read Times Threshold:** If the reading results of a barcode is same for the configured times, the barcode will be regarded as valid and its data will be outputted. Or the barcode will be regarded as invalid and its data will not be outputted.

Regular Expression Filter Mode

The device supports filtering codes via the regular expression.

Steps

1. Select **Regular Expression** as the **Filter Mode**, and click **Set** in **Regular Expression Filter** to enter regular expression filter settings window.
2. Import local files or add customized filter rules to set the regular expression.
 - Import local files: Click **Import** to import local .xml files, and click **OK** to finish.

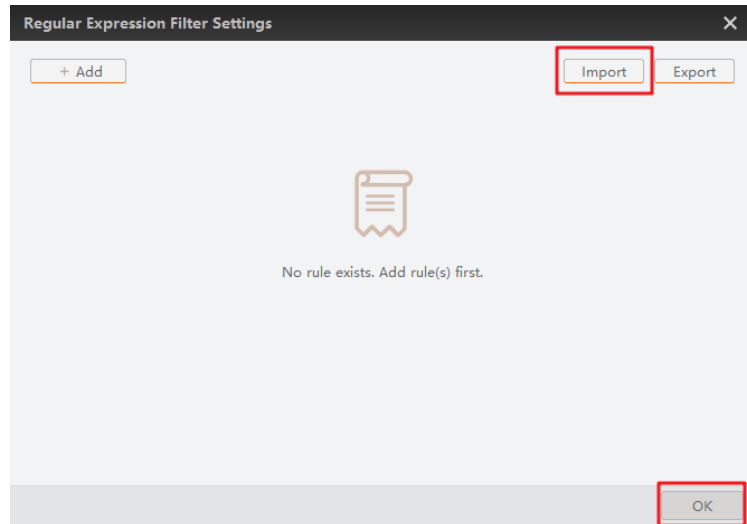

Figure 9-56 Regular Expression Filter Settings

- Add customized filter rule: Click **Add** and set related parameters in the popped-up window, and click **OK** after configuring parameters.

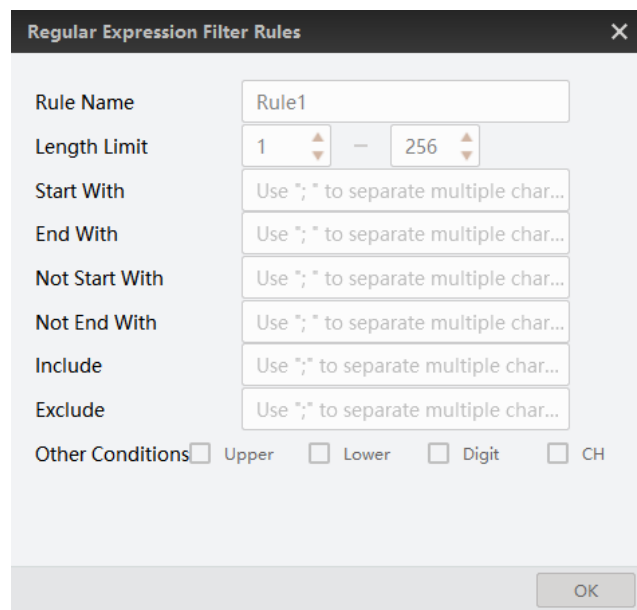







Figure 9-57 Enter Customized Regular Expression Filter Rules

Table 9-19 Filter Rule Parameters

Parameter	Description
Rule Name	The default rule name is Rule 1, and you can edit it according to actual demands.
Length Limit	It sets the length range of the code, and its upper limit is 256.
Start With	It sets the specific start with code. You can use semicolon to separate if there are multiple characters.

Parameter	Description
	<p> Note If multiple characters are used, code meeting one of these characters is valid.</p>
End With	<p>It sets the specific end with code. You can use semicolon to separate if there are multiple characters.</p> <p> Note If multiple characters are used, code meeting one of these characters is valid.</p>
Not Start With	<p>It excludes the specific start with code. You can use semicolon to separate if there are multiple characters.</p> <p> Note If multiple characters are used, code meeting one of these characters is valid.</p>
Not End With	<p>It excludes the specific end with code. You can use semicolon to separate if there are multiple characters.</p> <p> Note If multiple characters are used, code meeting one of these characters is valid.</p>
Included	<p>It sets the code with specific content. You can use semicolon to separate if there are multiple characters.</p> <p> Note If multiple characters are used, code meeting all these characters is valid.</p>
Excluded	<p>It sets the code without specific content. You can use semicolon to separate if there are multiple characters.</p> <p> Note If multiple characters are used, code meeting all these characters is valid.</p>
Other Conditions	<p>You can select uppercase, lowercase, digit or Chinese.</p>

3. After setting filter rule, enter the code in **Code Check** to check if the filter rule is successful.

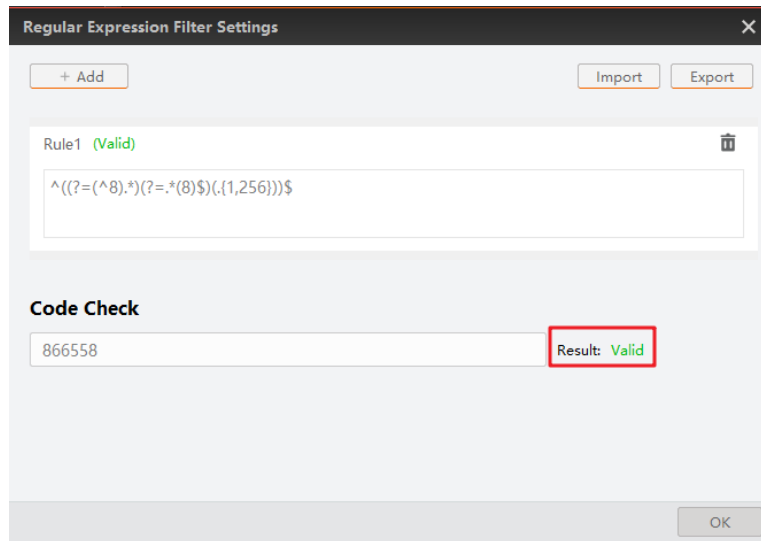

Figure 9-58 Code Check

Note

If the filter rule you configured is correct, the result is valid. Otherwise, it is invalid.

4. (Optional) Click  to delete unwanted filter rules.

5. (Optional) Click **Export** to export configured filter rules to local PC.

Note

The filter rule parameters of the regular expression may differ by device models and firmware versions.

9.7.2 Data Processing Settings

You can configure the contents contained in the output barcode information.

Note

- The actual parameters displayed may vary with different communication protocols. For details about communication settings, refer to **Communication Settings**.
- The specific parameters and parameter order may differ by the device's operation mode, trigger mode, device models and firmware versions.

SmartSDK

- **Sorting Rules:** Specify the sorting rules of output images. Multiple sorting rules are supported.
- **One By One Enable:** If it is enabled, the device will send one piece of code information

each time in accordance with the specified interval. You can set the interval via **One By One Interval** and the default value 100 ms.

- **Local Save Picture Mode:** It includes **Off**, **NoRead**, and **Insufficient Code**. You can select **NoRead** to let the device save images when no code is read.

FTP

When the communication protocol is FTP, set the following parameters of data processing:

- **Sorting Rules:** Specify the sorting rules of output images. Multiple sorting rules are supported.
- **One By One Enable:** If it is enabled, the device will send one piece of code information each time in accordance with the specified interval. You can set the interval via **One By One Interval** and the default value 100 ms.
- **Local Save Picture Mode:** It includes **Off**, **NoRead**, and **Insufficient Code**. You can select **NoRead** to let the device save images when no code is read.
- **Local Picture Type:** Specify the type of pictures saved locally. You can select **JPEG** or **BMP**.
- **Output Retrans Enable:** Enable to allow data re-transmission. Specify the limit of re-transmission attempts in **Output Retrans Number**.
- **FTP Picture Name Format:** Click  to select one or multiple items to be contained in the picture name. The selected items will be displayed in the frame. You can also enter more contents directly in the frame.
- **FTP Transmission Conditions:** Set the condition to upload the data outputted by the device to FTP server.
 - **All:** Always upload the data.
 - **ReadBarcode:** Upload the data only when the barcode is read by the device.
 - **NoReadBarcode:** Upload the data only when no barcode is read by the device.
- **FTP Transmission Result Contain:** Select contents to upload to the FTP server.
 - **JustResult:** Only upload the content of the barcode.
 - **JustPicture:** Only upload the barcode image.
 - **ResultAndPicture:** Upload both the content of the barcode and the barcode image.
- **FTP Time Format:** Select a format type from the drop-down list for the time stamp contained in the file name.

Note

Take YYYYMMDD_HHMMSSFFF as an example, (from the left to the right) YYYY represents year, MM month, DD date, HH hour, MM minute, SS second, FFF millisecond.

- **FTP Save Picture Strategy:** Select from the drop-down list the picture saving strategy from **Recent Frame**, **All Frames**, **Range Frames**, and **Specific Frame** accordingly. If **Specific Frame** is selected, you can specify the frame by entering its index in the box of FTP Picture Index.
- **FTP Picture Index:** Set the picture index.

TCP Client / Serial / TCP Server / Profinet / MELSEC / EthernetIp / Modbus / UDP / FINS

When the communication protocol is TCP Client / Serial / TCP Server / Profinet / MELSEC / EthernetIp / Modbus / UDP / FINS, set the following parameters of data processing.

Note

Here we use “***” to represent the specific protocol name.

- **Sorting Rules:** Specify the sorting rules of output images. Multiple sorting rules are supported.
- **One By One Enable:** If it is enabled, the device will send one piece of code information each time in accordance with the specified interval. You can set the interval via **One By One Interval** and the default value 100 ms.
- **Local Save Picture Mode:** It includes **Off**, **NoRead**, and **Insufficient Code**. You can select **NoRead** to let the device save images when no code is read.
- ***** Output Format:** Click  to select one or multiple items to be contained in the picture name. The selected items will be displayed in the frame. You can also enter more contents directly in the frame.
- ***** Output Noread Enable:** Enable this to set the default output content if no barcode is read during transmission. Edit the output text in **Output NoRead Text**.
- ***** Output Start Text:** The contents of the start part of the data outputted. You can set the contents as desired.
- ***** Output Stop Text:** The contents of the end part of the data outputted. You can set the contents as desired.
- ***** Output Barcode Enter Character Enable:** Whether to show input character in the data.
- ***** Output Barcode Newline Character Enable:** Whether to show new-line character in the data.

9.8 Contrast Control Settings

Note

You need to set device's operation mode as normal before using this function.

The contrast control function compares the data that the device reads with preset data and outputs contrast result. The result can be used as the event source of trigger signal, including **Contrast Success** and **Contrast Fail**. This function has two ways to contrast, including regular contrast and consecutive number contrast.

Regular Contrast

The regular contrast requires you to set code contents in advance, and the client software will contrast the data that the device reads with preset contents and outputs comparison

result.

Steps

1. Right click the device in **Device Connection**, and click **Feature Tree**.
2. Go to **Contrast Control**, enable **Contrast Enable**, and select **Regular** as **Contrast Rules**.
3. Set **Start Position** that means the starting position of the comparison.
4. Set **Character Number** that means the comparison quantity.
5. Set code contents in **Wildcard String**.

Note

You can use wildcard * and ?. * stands for multiple strings you can use, and ? stands for one string you can use. * can be used once only and ? can be used many times.

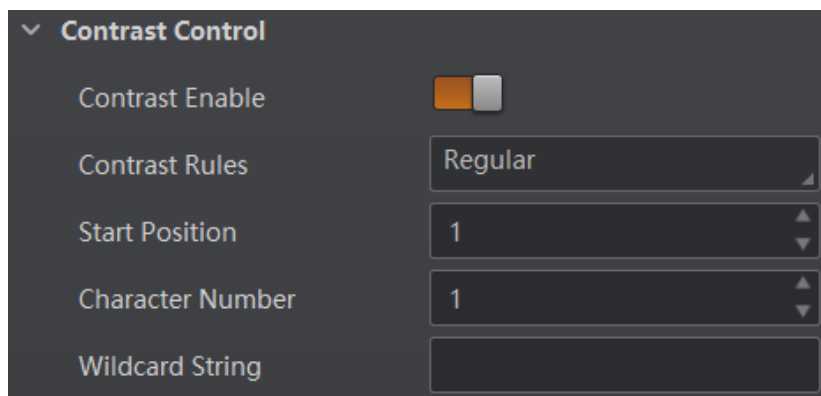

Figure 9-59 Regular Contrast

Consecutive Number Contrast

The consecutive number contrast requires you to set consecutive code rules, and the client software will contrast the data that the device reads with preset rules and outputs contrast result.

Steps

1. Right click the device in **Device Connection**, and click **Feature Tree**.
2. Go to **Contrast Control**, enable **Contrast Enable**, and select **Consecutive Number** as **Compare Rules**.
3. Set **Start Position** that means the starting position of the comparison.
4. Set **Digital Number** that means the comparison quantity.
5. Set **Step** that means the client software will increase or decrease the preset value after each comparison according the step you set.

Note

- If the preset value after increase or decrease exceeds the digital number you set, and then the preset value will become 0.
 - The base value displays the preset value.
-

6. (Optional) Click **Execute** in **Contrast Reset** to reset comparison. After that, the client software will use the first code it reads as the preset value.

Here we take start position (3), digital number (2) and step (2) as an example to explain the consecutive number comparison:

- If the first code that the device reads is ur96k, and then the preset value is 96. The preset value increases to 98 (96+2).
- If the second code is yr98kjkfd, and comparison succeeds. The preset value increases to 100 (98+2).
- If the third code is kl99fjkd, and comparison fails. The preset value does not increase.
- If the fourth code is kl00djf, and comparison succeeds. The preset value increases to 02 (00+2).

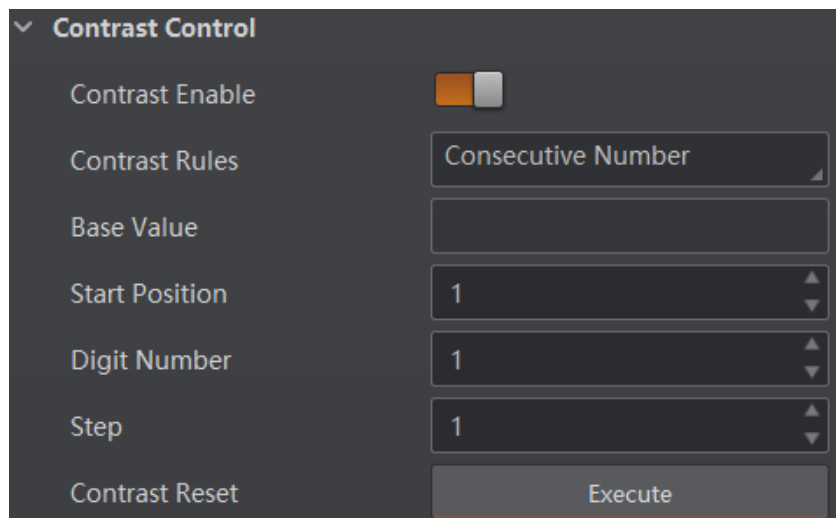

Figure 9-60 Consecutive Number Contrast

9.9 Statistics Information

The statistics information in the feature tree helps you to count data related with code reading.

Note

You need to set device's operation mode as normal before using this function.

Steps

1. Right click the device in **Device Connection**, and click **Feature Tree**.
2. Go to feature tree, find **Statistics Info.**, and select **Statistics Mode**:
 - **All Frames** means the client software will display all data since the device is powered on.
 - **Latest Frames** means the client software will display data of the last 10 frames.
3. View related parameters.
4. (Optional) Click **Execute** in **Reset Statistics** to reset statistics information.

Table 9-20 Parameter Description

Parameter Name	Description
Total Frame Number	The total frame quantity.
Read Frame Number	The quantity of frames that have been read codes.
Noread Frame Number	The quantity of frames that have not been read codes.
Read Rate	It refers to the code reading ratio.
Algo Time Ave.	The average time of algorithm, and the unit is ms.
Algo Time Max.	The max. time of algorithm, and the unit is ms.
Algo Time Min.	The min. time of algorithm, and the unit is ms.
Read Time Ave.	The average time of code reading, and the unit is ms.
Read Time Max.	The max. time of code reading, and the unit is ms.
Read Time Min.	The min. time of code reading, and the unit is ms.
Reset Statistics	Click Execute to reset statistics information.

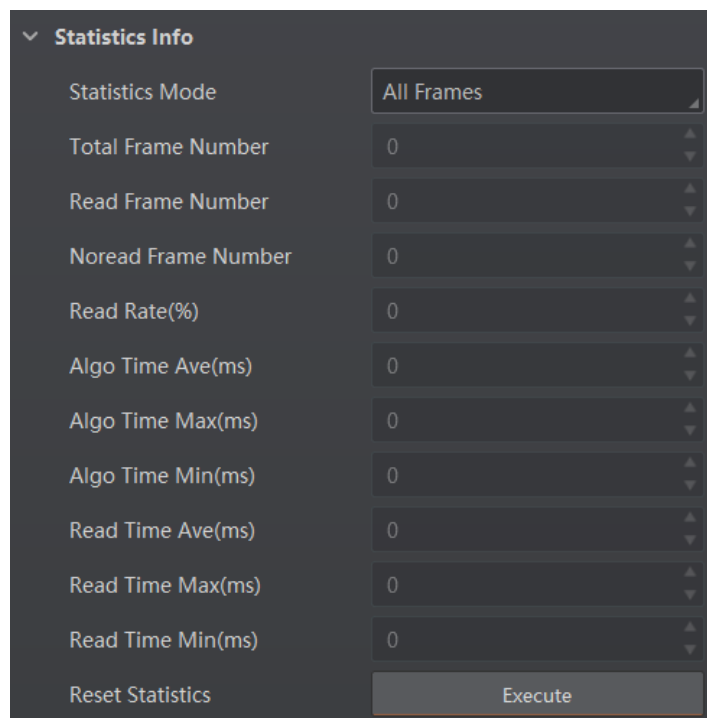

Figure 9-61 Statistics Information

9.10 Diagnose Event Report

The diagnose event report function monitors memory and CPU usage rate, and let you know

when there is a crash, higher CPU usage rate, insufficient memory, and other events.

Steps

1. Right click the device in **Device Connection**, and click **Feature Tree**.
2. Go to feature tree, find **Diagnose Event Report**.
3. View relation information.
4. (Optional) Click **Execute** in **Reset Event** to clear all information.

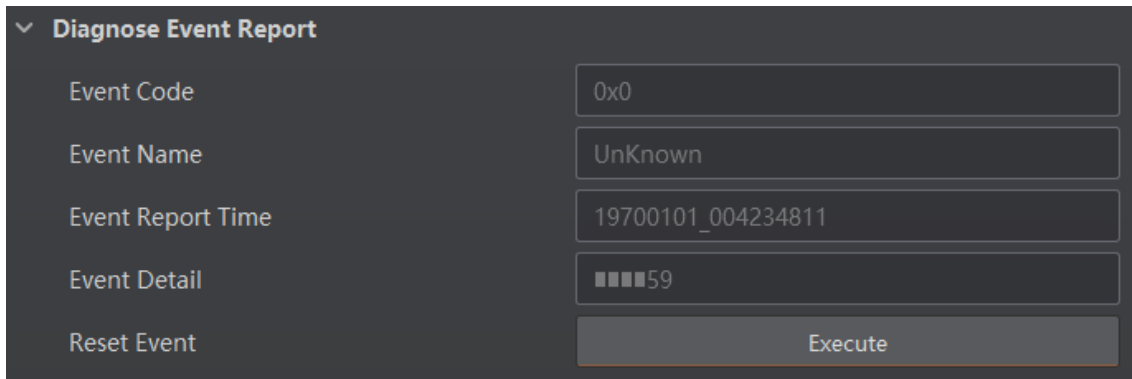

Diagnose Event Report	
Event Code	0x0
Event Name	UnKnown
Event Report Time	19700101_004234811
Event Detail	■■■■59
Reset Event	Execute

Figure 9-62 Event Report

9.11 User Set Customization

In **Configuration Management**, you can set and manage the user set. A user set is a group of parameter values with all the settings needed to control the device, and you can save, load and switch different user sets.

- **Save Settings:** If you have set the device parameters as desired, you can save them into the user set. Go to **Config Management** → **Save Settings**, and click **UserSet1**, **UserSet2**, or **UserSet3** to save the current device settings.
- **Load Settings:** You can load the user set to restore the device to the saved group of parameter values again if required. Go to **Config Management** → **Load Settings**, and click **Default**, **UserSet1**, **UserSet2**, or **UserSet3** to load settings.

Note

The **Default** refers to restore the device parameter settings to the factory ones.

- **Start Settings:** The selected user set will be automatically loaded after the device being powered on. For example, if you select **Default**, the device parameter settings will be restored to the factory settings.

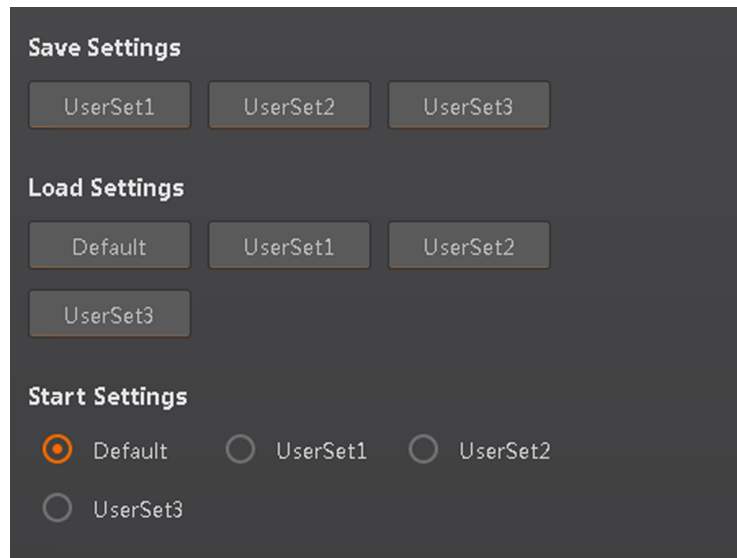

Figure 9-63 User Set Customization

Chapter 10 Device Maintenance

10.1 Update Firmware

The device supports updating firmware via the client software.

Note

- Disconnect the device with client software.
 - Please use the firmware package of the corresponding device model for upgrading.
 - Do not power off the device or disconnect network during upgrading.
 - The device will restart automatically after updating the firmware.
-

Steps

1. Select the device to be updated in the device list, and right click the device.
 2. Click **Firmware Update**.
 3. Click  to select update file from local PC, and click **Update** to update firmware.
-

Note

You can also go to **Tool** → **Firmware Updater** to update firmware.

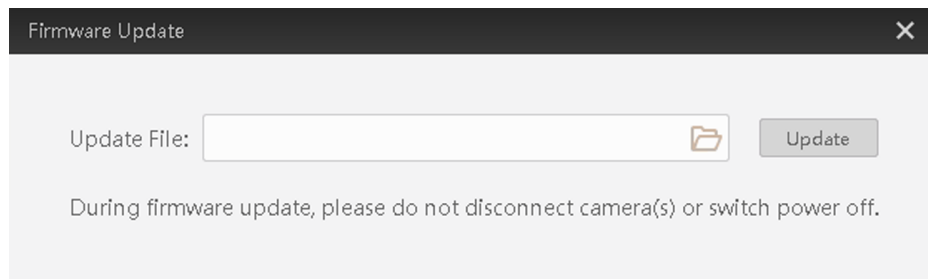

Figure 10-1 Update Firmware

10.2 Set Time

After enabling NTP time synchronization, the device will synchronize time according to the configured interval.

Steps

1. Go to **Config Management**, and find **Timing**.
2. Click **Setting** and enable **NTP Enable**.
3. Set parameters according to actual demands.

Note

Configure NTP server settings before using NTP time synchronization function.

4. Click **OK** after settings.

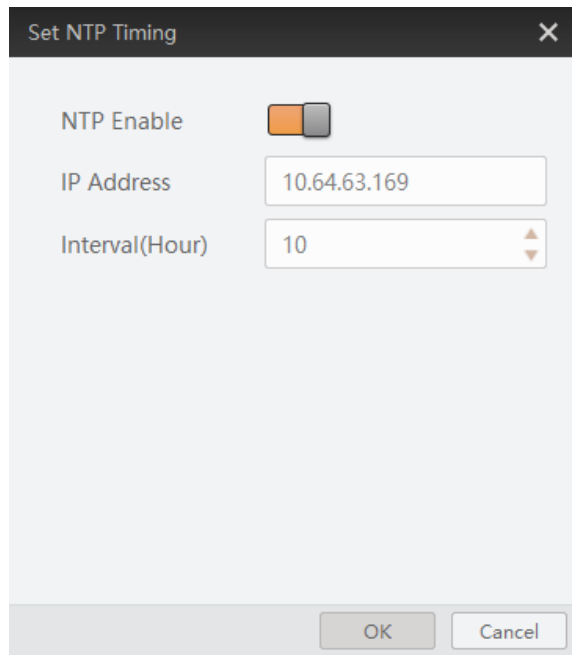

Figure 10-2 Set NTP Timing

10.3 Enable Device Auto Work

This function allows the device to automatically enter the operation status after being powered on.

You can go to **Config Management** → **Device Auto Work Enable**, and enable **Device Auto Work Enable**.

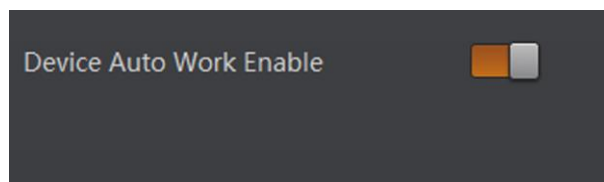

Figure 10-3 Enable Device Auto Work

10.4 Restart Device

You can restart the device via client software in 2 ways. Go to **Config Management**, and click **Restart Device**. Or, you can select the device to be restarted in the device list, right click the device, and click **Device Reset**.

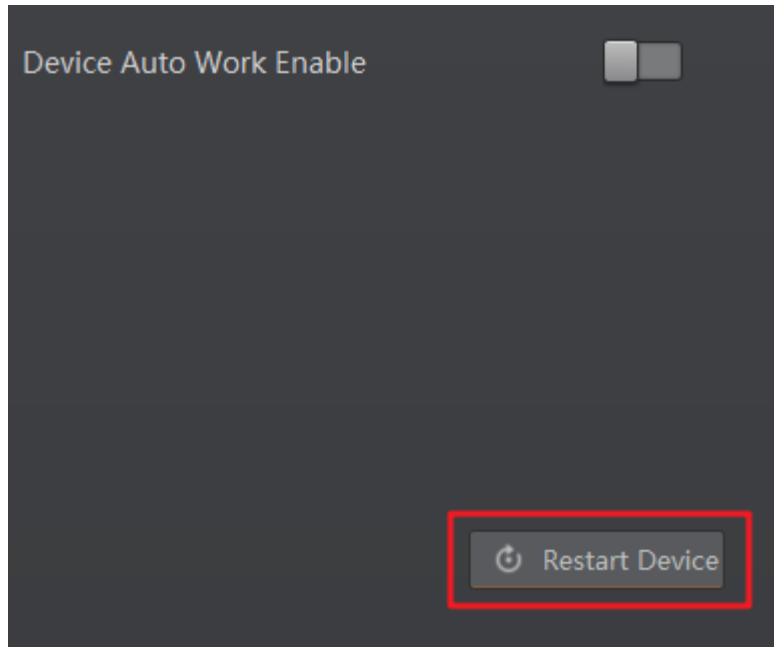

Figure 10-4 Restart Device

Chapter 11 FAQ (Frequently Asked Question)

11.1 Why there is no device listed after I run the IDMVS client software?

Problem

Run IDMVS client, there is no listed device.

Reason

- The device is powered off.
- Network exception.

Solution

- Check the device's power connection (observe whether the top indicator is in blue color or not) to make sure the device is powered up normally.
- Check the network connection (the top indicator is solid yellow if the network exception occurs) to make sure the device can be connected to the network normally, and make sure that the PC and the device are in the same network segment.

11.2 Why the image is very dark?

Problem

All black or too dark during live view.

Reason

- Insufficient brightness of light source.
- Too small value of exposure and gain.

Solution

- Increase the brightness of light source appropriately, or change to a brighter one.
- Increase exposure and gain appropriately.

11.3 Why the image's frame rate is very low in the live view?

Problem

Image incoherent/low frame rate/image tearing when adjusting images.

Reason

Network circuitry speed is not 100 Mbps.

Solution

Check whether the network transit speed is 100 Mbps or not.

11.4 Why there is no image in the live view?

Problem

No image in the live view.

Reason

- Enabled trigger mode, but there is no trigger signal.
- Network circuitry speed is not 100 Mbps.

Solution

- Sent the trigger signal to the device, or disable the trigger mode.
- Check whether the network circuitry speed is 100 Mbps or not.



HIKROBOT

SHAPE OUR FUTURE INTELLIGENTLY

Hikrobot Co., Ltd.

Tel: 400-989-7998

Website: <https://en.hikrobotics.com/>

UD34687B